

Mobile Printer

HM-E300

USER MANUAL



Rev.1.1

Manufacturer: Xiamen Hanin Electronic Technology Co.,Ltd.

ADD: No.96, Rongyuan Road, Tong'an District, Xiamen, China 361100

E-mail: support@hpert.com

Web: www.hpert.com

Caution Symbol



Never touch the thermal head immediately after the printer has been used. Let the thermal head cool for a few minutes before touching it.



This symbol is indicate that it is easily damaged. Observe the precautions for handling electrostatic sensitive devices.

Safety Precautions

Please be sure to read

To use this product in safety, please follow the precautions given below.



WARNING

- ✓ If you notice smoke, a strange smell, or a strange sound, turn off the power immediately, and remove the USB cable and/or battery pack. Then contact the dealer.
 - ✓ If any foreign material (metal scraps, water, or other fluid) enters the printer, immediately turn off the printer and remove the USB cable and/or battery pack. Then, contact your dealer for advice. Continued use of the printer could result in a fire.
 - ✓ Never attempt to repair the printer yourself. Also do not disassemble or modify the product. Doing so could lead to injury, fire, or electric shock.
 - ✓ Do not touch the tear bar.
 - ← There is a tear bar inside the paper outlet slot. Neither put your hand in the paper outlet slot while printing is in progress, or put your hand into the outlet even when printing is not in progress.
 - ← The printer cover can be opened when replacing the paper. However, since the tear bar is on the inside of the printer cover, be careful not to place your face or hands too close to the tear bar.
 - ✓ During and immediately after printing, the area around the thermal head is very hot. Do not touch it, as you could be burned.
 - ✓ If any battery fluid gets on your skin or clothing, immediately wash the affected area with fresh water. Otherwise, skin damage may result.
 - ✓ The battery pack may be hot immediately after the product has been used.
-

■ Using the Printer

- ✓ Some semiconductors can be damaged by static electricity. Be sure to turn off the printer when inserting or removing the battery pack.
- ✓ Do not drop the printer or hit it against a hard object.
- ✓ Do not open the printer cover while the printer is printing.
- ✓ Before you open the printer cover, make sure that printing data is not being sent to the printer.
- ✓ Do not unplug or plug in a USB cable while the printer is printing or during communication.
- ✓ Do not touch a USB connector while the printer is printing.
- ✓ Turn off the printer when you are not using it.
- ✓ When the printer is used in a low temperature environment, the battery's performance will be diminished, and the amount of time that you can use the printer for may be reduced.
- ✓ Do not pull out paper while the printer cover is closed.
- ✓ The heating element and the driver IC of the thermal head are easily damaged. Do not touch them with metal objects, sandpaper, etc.
- ✓ Printing quality may suffer if the thermal head heating element becomes soiled by being touched with your hands. Do not touch the thermal head heating element.
- ✓ There is a risk of damage to the driver IC of the thermal head from static electricity. Never directly touch the IC.
- ✓ Do not operate the printer if there is moisture on the front surface of the head from condensation, etc.

■ Thermal Paper Handling

- ✓ Only use thermal paper with the designated specifications. The printing quality and working life of the thermal head cannot be guaranteed if any paper other than that recommended is used. In particular, if ion concentration of [Na⁺, K⁺, Cl⁻] is high, it may drastically reduce the working life of the thermal head. Please exercise caution.
 - ✓ Store the thermal paper in a cool, dry, dark location.
 - ✓ Do not rub the thermal paper with a hard object.
 - ✓ Do not leave the thermal paper in contact with plastic film, an eraser, or adhesive tape for a long period of time.
 - ✓ Do not stack the thermal paper on fresh diazo copies or wet-type copies.
 - ✓ Do not use chemical glue on the thermal paper.
 - ✓ Do not use thermal paper that has been stored for a long period.
-

■ Operating Environment for the Printer

Before actually unpacking the printer, remember the following points when doing this.

- ✓ Do not use the printer in an environment in which it will be subject to strong shaking while it is printing.
- ✓ Be careful to ensure that the printer is not exposed to direct sunlight.

The appropriate environment for using the printer is described below.

Temperature: -5°C to 50°C

Humidity: 25% RH to 85% RH (no condensation)

- ✓ Do not place the printer near a copying machine or other device that produces a strong electromagnetic field.
- ✓ Keep the printer sufficiently removed from heaters and other sources of heat.
- ✓ Use the printer in a clean, low-humidity environment that is free from dust.
- ✓ Avoid using the printer in high-humidity rooms.

■ Printer Maintenance

Please perform the following maintenance every 6 months.

- ✓ Thermal head
 - Dip a cotton swab in an alcohol solvent (ethanol, methanol, or isopropyl alcohol), and clean the heating area of the head.
- ✓ Platen
 - While turning the platen, use a soft dry cloth to lightly rub the entire surface of the platen and remove any foreign objects.
- ✓ Paper storage unit and the surrounding area
 - Remove any dirt, dust, pieces of paper, etc., from the paper storage unit.
- ✓ Card reader
 - Regularly blow air onto the card reader to remove any dust from the card slot.

■ Using a Magnetic Card

- ✓ Do not bring magnets near the card, and do not store the card near a device that produces a magnetic field (such as a mobile phone, speaker, or TV). If you do so, the data on the card may be deleted.
 - ✓ Do not leave the card in a high-temperature environment (such as the dashboard of a car). If you do so, the card may bend.
 - ✓ Do not touch the card with dirty or wet hands. Also, do not attach adhesive tape or glue to the card. Failing to follow the above precautions could cause the card to stop working properly.
-

Contents

1. Product Overview.....	1
1.1 Printer & Accessories.....	2
1.2 Appearance and Components.....	3
2. Setup.....	4
2.1 Battery Pack.....	4
2.1.1 Inserting into the Printer.....	4
2.1.2 Charging the Battery.....	5
2.2 Bluetooth.....	8
2.3 Loading Paper.....	9
2.4 Menu Settings.....	12
2.5 Belt Clip.....	17
2.5.1 Install the Belt Clip.....	17
2.5.2 Using the Belt Clip.....	17
3. Printer Features.....	18
3.1 Control Panel.....	18
3.1.1 Button.....	18
3.1.2 Panel Lamp.....	19
3.1.3 LCD Indication.....	19
3.1.4 Buzzer Description.....	20
3.2 Self Test.....	21
3.2.1 Self Test Procedure.....	21
3.2.2 Printing the Bluetooth Device Name and Barcode Information.....	21
3.3 Instruction for Standby(Sleep) Mode.....	22
3.4 Magnetic Card Reader.....	23
4. Paper.....	25
4.1 Paper Specification.....	25
4.2 Recommended Paper.....	25
4.3 Printing Range.....	25
4.4 Specification of Black Mark.....	26
5. General Specification.....	27
6. Detailed Specification.....	30
7. Interface.....	31
7.1 USB for Battery Charge.....	31
7.2 Bluetooth.....	32
8. Specifications of Accessories.....	33
8.1 Battery Pack.....	33

8.2 Belt Clip.....	33
9. Troubleshooting Procedure.....	34
9.1 Troubleshooting Guide.....	35
9.1.1 Power Supply Failure.....	35
9.1.2 Printing Failure.....	35
9.1.3 Faulty Sensor.....	36
9.1.4 Paper Feed Failure.....	36
9.1.5 Error Message(Printer Status indication on the LCD).....	37
10. Windows Driver.....	38
10.1 Operating System.....	38
10.2 Windows Driver Preparation.....	38
10.3 Windows Driver Installation.....	38
10.4 Detailed Windows Driver Setting.....	42
10.4.1 Printing Preferences.....	42
10.4.2 Other Settings.....	51
10.5 Uninstalling the Driver.....	54
11. Utility Tool Instruction.....	56
11.1 Operating System (OS) Environment.....	56
11.2 Utility Tool Preparation.....	56
11.3 Using Utility Tool.....	57
11.3.1 Add Printer.....	58
11.3.2 Modify Printer.....	60
11.3.3 Delete Printer.....	62
11.3.4 Connection Test.....	63
11.4 Functions.....	64
11.4.1 Print Text.....	65
11.4.2 Print Self Information.....	65
11.4.3 Download Fonts.....	66
11.4.4 Parameter Configuration.....	66
11.4.5 Command Test.....	67
11.4.6 Download Images.....	67
11.4.7 WIFI Configuration.....	68
11.5 Firmware Update.....	69

1. Product Overview

This printer is perfect for mobile banking systems, retail, POS (point of sale) terminals and other forms of mobile computing.

The characteristics of this printer are listed below:

- Pocket size (106.2x139.1x61.9mm)
- Extremely light and mobile (400g including Battery pack)
- Very silent printing thru direct thermal printing method
- Print speed max.70mm/s
- Support Bluetooth Ver3.0/4.0[BLE] Dual Mode
- Support Secure Magnetic Stripe Reader <Model with Card Reader>
 - *AES or 3DES encryption
 - *DUKPT Key Management
- Support Graphic LCD(128x64 dots) with Blue Backlight
- Belt Clip as a standard accessory
- Support text and graphic printing
- easy to load paper
- A printer cover that can be opened with the touch of a button
- Printer cover open sensor, Paper-out sensor, Black mark sensor, Label gap detection

1.1 Printer & Accessories

The printer is packaged with the following accessories.

If any of these accessories is broken or missing, please contact the dealer that you bought the product.



Printer



USB Cable

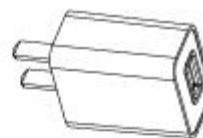

AC Adapter



Battery Pack



Roll Paper



Belt Clip



Quick Start Guide

Note:

1) The AC adapter varies by country or region.

2) The packing items are actually dependent on the order.

1.2 Appearance and Components

▪ Front

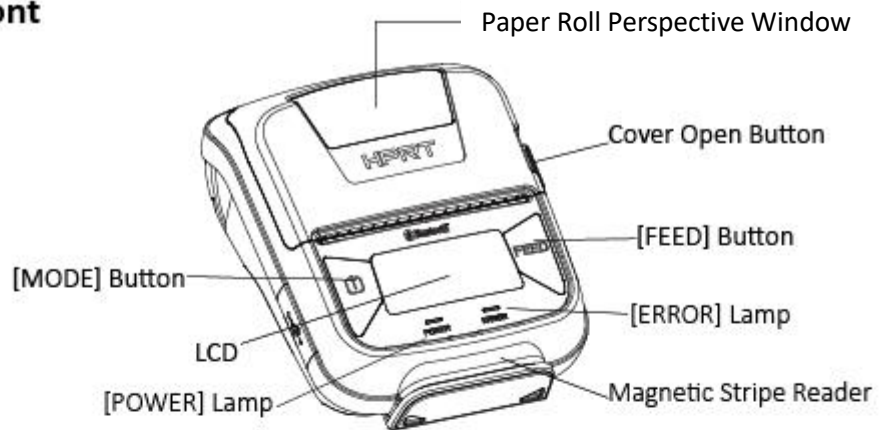

▪ Rear

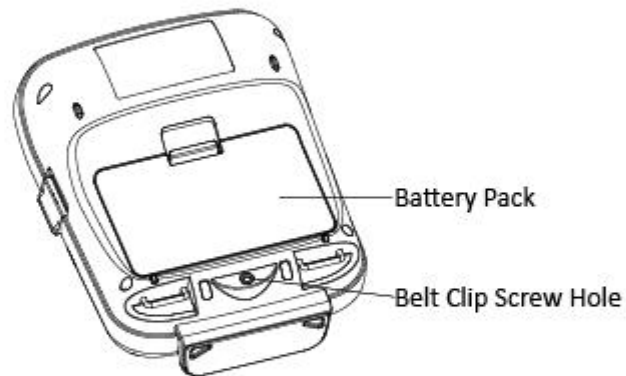

▪ Inside

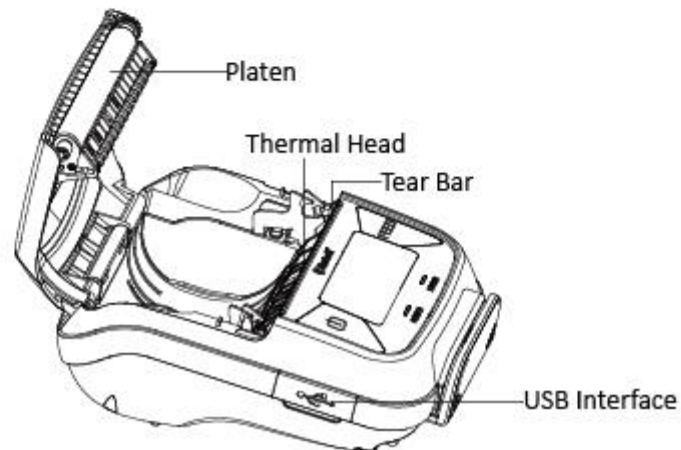

2. Setup

2.1 Battery Pack

2.1.1 Inserting into the Printer

1. Make sure that the printer has been turned off before you insert or remove the battery pack.
2. Insert the battery pack into the back of the printer as in the figure shown below, following the direction of the arrow. Press down on the battery pack until the hooks click into place.



3. To remove the battery back, pull back the hook, and use the opposite procedure from the one you used to insert the battery pack.



2.1.2 Charging the Battery

Insert the battery pack into the printer to charge it.

Plug in socket with USB charging.

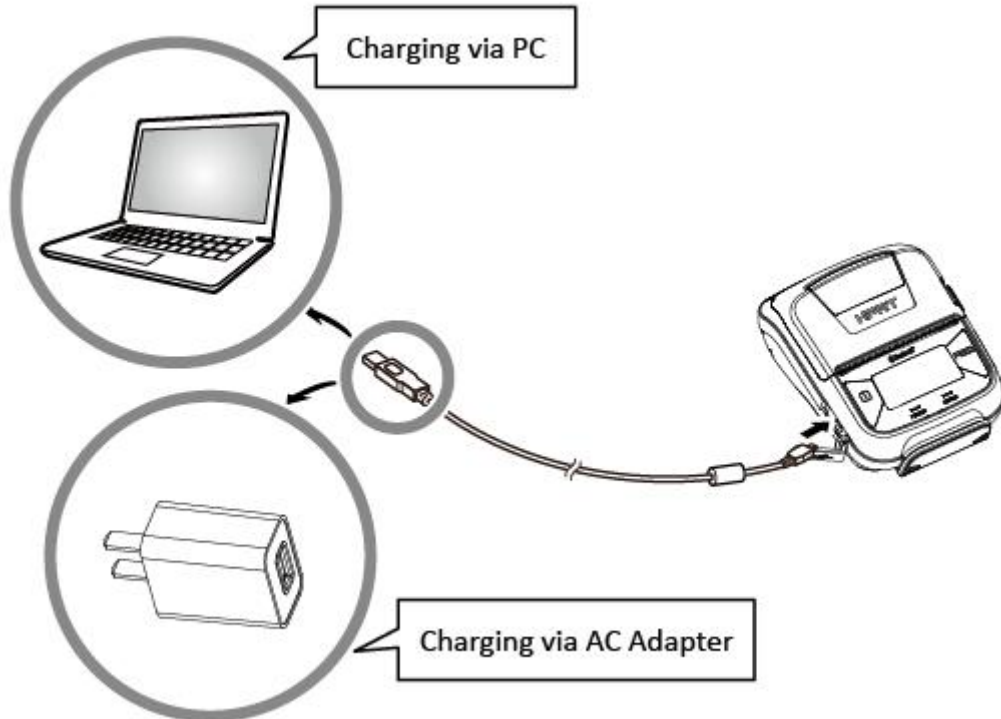

When battery pack runs out of power, the battery icon will flash. It powers off automatically when continues printing. If you want to go on, please charge it.

Battery charging

- ◆ POWER lamp will always flash in green color and goes off when fully charged.



Notes about the Battery Pack

◆ General Battery Characteristics

- The battery is a consumable and its performance over time gradually decreases.
- While not in use, the battery will slowly discharge itself.
Prepare a battery pack that has been charged relatively recently (1 to 2 days earlier).
- To ensure that the battery lasts for a long time, we recommend that you turn off the printer whenever possible.
- When used at low temperatures, battery performance will temporarily decline. Be sure to have a fully-charged spare battery standing by if the printer will operate in a cold environment.

◆ Charging the Battery Pack

- The battery pack can be charged at ambient temperatures between 0 and 40°C.
- The time required to charge the battery pack varies depending on the voltage and the ambient temperature.

Normally, it takes 3 to 4 hours to charge the battery pack.

- It will take longer to charge the battery pack if you print while charging the battery pack.
- Do not remove the battery pack while it is being charged.
- Fully charge the battery prior to using the printer. Otherwise, the performance of the battery may be affected.
- There is no need to completely discharge or use up a rechargeable Lithium-ion battery before recharge it.
- It is normal for the battery pack to be hot after it has finished charging or been used.

◆ Notes about Using the Battery Pack

- Only use a designated battery pack.
- Only use the designated battery charging method.
You cannot use a USB cable other than the designated USB cable.
- Do not throw the battery into a fire, place it near a flame or heating device, or leave it in a hot environment (under direct sunlight, in a car, etc.).
- Do not use a battery pack that has been dropped or subjected to a shock in some other way.
- Do not disassemble or modify the battery pack.
- Do not short the terminals of the battery pack or get it wet.
- Do not place the battery pack in a bag with a small metal object (such as a key).
- If any battery fluid gets on your skin or clothing, immediately wash the affected area with fresh water. Otherwise, skin damage may result.

◆ Notes about Storing the Battery Pack

- If you do not intend to use the battery pack for a long time, be sure to remove it from the printer.
- Keep the battery out of the reach of children. In addition, be careful that children do not remove the battery.
- Store the battery pack in a cool place.

* We recommend that you store the battery pack in a dry area with an ambient temperature of 15 to 25 °C.

* Avoid storing the battery in locations with high or extremely low temperatures.

◆ **Battery Disposal and Recycling**

A battery pack is used to power this device. Since the disposal process of batteries varies from country to country, refer to the appropriate measures mandating the disposal method of the country in which this device is used.

If the battery pack is not in use for a long time, please remove it after fully charged. And it should be recharged every 3 months.

When power is low, battery should be charged in time. If the printer automatically power down because of low power, be sure to charge the battery in 15 days. Otherwise, it will cause permanent damage to the battery.

2.2 Bluetooth

1. Press and hold MODE button for approx. 2 seconds, and printer is turned on.
Then, it is ready to pair with another Bluetooth device.

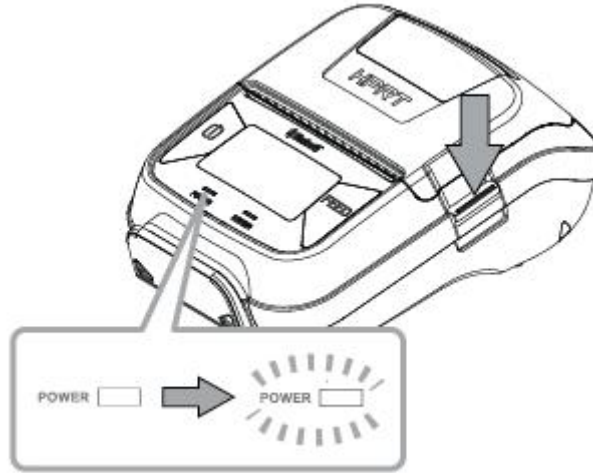

2. If necessary, enter the following information into the terminal that you are using.
PIN: 1234 (default)
Device name: "HM-E300-XXXXX" (default)
(XXXXX is the last digits of the Product Serial Number)

Notes:

1. HM-E300 has two Bluetooth modes:
 - a) One is Bluetooth Ver3.0 with PIN for Android or Windows system. PIN and Device name can be changed through Star Utility. To obtain this utility, please contact with your dealer.
 - b) Another is Bluetooth 4.0(BLE) without PIN for iOS system.
2. HM-E300 changes the Bluetooth mode automatically by host system.
3. Pairing sets one by one in order, otherwise it can't figure out which one succeeds in pairing.

2.3 Loading Paper

Refer to Section 4 “Paper” (p. 25), to select roll paper that conforms to the specifications.

1) Press the cover open button to open the paper cover.

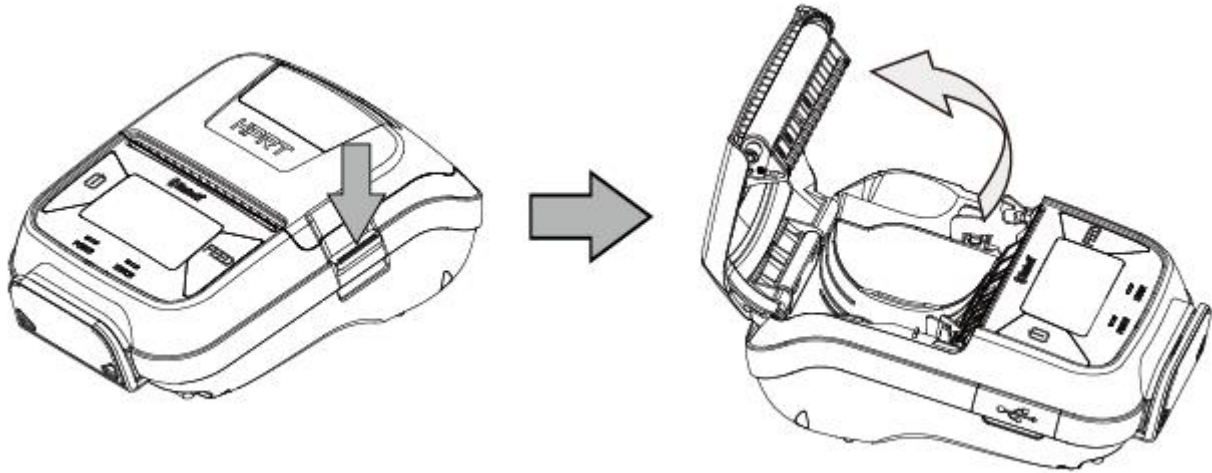

2) Load the roll paper in the orientation shown in the figure below.

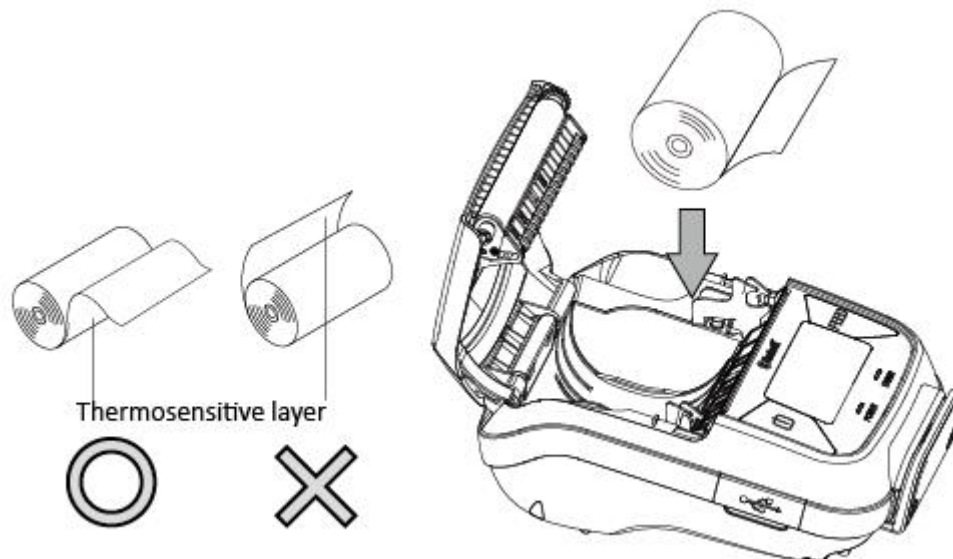

3) Pull the end of the roll straight toward you. Then press down on both sides of the printer cover to close it firmly. When you close the printer cover, make sure that it is closed on both sides.

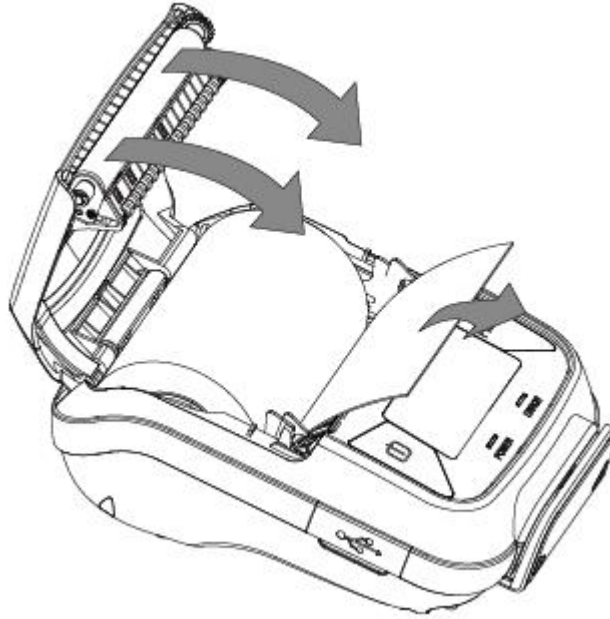

4) Use the tear bar to cut the extra paper.

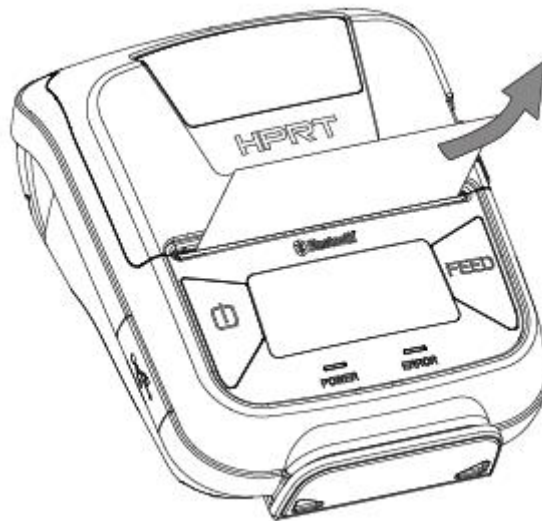

⚠ CAUTION

When ERROR lamp is flashing, please make sure the cover is closed correctly. If it's not, open the cover and close it correctly.

When the paper is jammed, be sure to open the printer cover before removing the jammed paper.

Do not under any circumstances try to pull out the jammed paper forcefully while the printer cover is closed, doing so may damage parts of the printer.

Caution Symbol



Never touch the thermal head immediately after the printer has been used.

Also, even when the thermal head is not hot, do not touch it, because static electricity can damage the devices inside the thermal head.

WARNING

1) Do not touch the tear bar.

- There is a tear bar inside the paper outlet slot. You could neither put your hand in the paper outlet slot while printing is in progress nor put your hand into the outlet even when printing is not in progress.
- The paper cover can be opened when replacing the paper, be careful not to place your face or hands too close to the tear bar.

2) During and immediately after printing, the area around the thermal head is very hot. Do not touch it, as you could be burned.

2.4 Menu Settings

Change the Menu settings by following operations. (Refer to P16 “Menu Setting Table”)

1. Press and hold the MODE button for approx. 2 seconds, and printer is turned on.

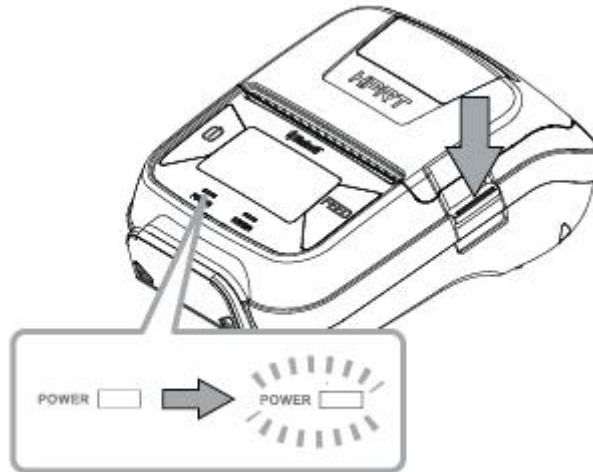

2. Press and hold both the MODE & FEED. Release the buttons after printer displays “Enter Menu Mode”, then you can configure the settings.

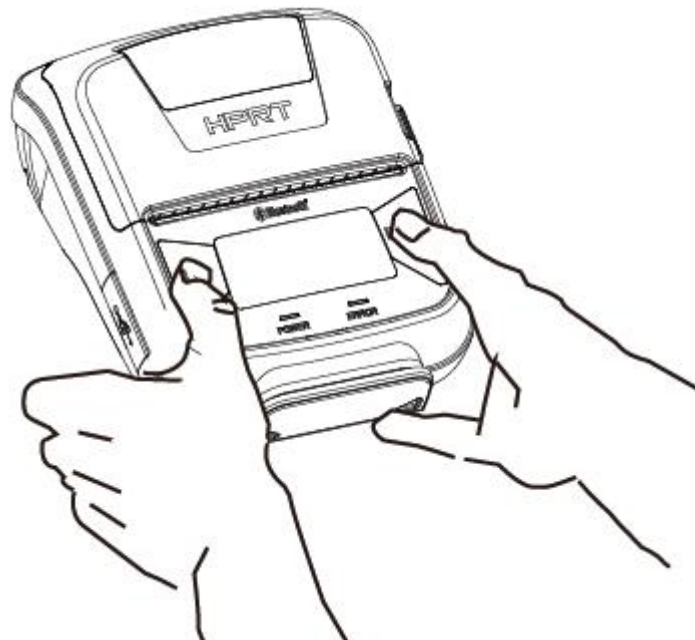

3. To switch the Menu and option parameter , or return to the previous menu, press MODE button.
4. To move the cursor(“_”), entry the printer mode, or confirm the new setting, press FEED button.

CAUTION

Before changing the menu setting, make sure that the communication with a host device is disconnected.

When the printer is under the Bluetooth communication with a host device, it cannot enter the Menu Settings mode.

Example

When you want to change the settings of the printer mode as shown below,

Item	Factory Setting	Configuration Example
1 Density	0(Medium)	1(Low)
2 Standby Time	0060(Sec)	0080(Sec)
3 Auto Off Time	0120(Min)	1120(Min)
4 Paper Type	0(Receipt)	2(BM(2inch))
5 Language	0(EN)	1(CH)
6 Factory Reset	0(N)	1(Y)

Press and hold the MODE & FEED buttons for 5 seconds.

→You will see present “Enter Menu Mode” in the LCD.

Press the MODE button once to switch the menu item.

Display: 1 Self Test →2 System Setting

→Press and hold the FEED button for 2 seconds to get into the menu.

Display: 1 Density
2 Standby Time
3 Auto Off Time
4 Paper Type
5 Language
6 Factory Reset
7 Prior Menu

➤ Press MODE button to switch the menu item, then press the FEED button once to enter the menu.

→Press the FEED button once to get into the Density menu.

Display: Density:
0-Low 1-Medium
2-High 1
3-Special

→Press the MODE button once to input the number 1, then press and hold FEED button to confirm the new setting and return to the previous menu.

1(Medium) → 2(High)

Please use at a room temperature if you want to set the density to ‘3 Special’.
Some type of the paper are not suitable for use in low temperature environment.

- Press the MODE button once to switch the menu item--Standby Time.

→Press the FEED button once to get into the menu.

Display: Standby Time:
 [0010-9999(Sec)]
 0060

→Press the FEED button twice to move cursor("—"), then press the MODE button twice to input the number: 8, finally press and hold FEED button to confirm the new setting and return to the previous menu.

(The standby time has set to 80 seconds)

0060(Sec) →0080(Sec)

When set the parameter to 0000, the standby time becomes invalid.

If set the parameter to 0001~ 0009, it will return to the previous setting, so do not set it.

- Press the MODE button twice to switch the menu item--Auto Off Time.

→Press the FEED button once to get into the menu.

Display: Auto Off Time:
 [0000-9999(Min)]
 0120

→Press the MODE button once to input the number on : 1, then press and hold FEED button to confirm the new setting and return to previous menu.

(The power off time has set to 1120 minutes)

0120(Min) →1120(Min)

When set the parameter to 0000, the power off time becomes invalid.

- Press the MODE button 3 times to switch the menu item--Paper Type.

→Press the FEED button once to get into the menu.

Display: 0-Receipt
 1-Label
 2-BM(2inch) 0
 3-BM(3inch)

→Press the MODE button twice to input the number:2, then press and hold FEED button to confirm the new setting and return to the previous menu.

(The paper type has set to BM(Center B))

0(Receipt) →2(BM(2inch))

- Press the MODE button 4 times to switch the menu item--Language.

→Press the FEED button once to get into the menu.

Display: Language
 0-EN 1-CH

0

- Press the MODE button 5 times to switch the menu item--Factory Reset.

→Press the FEED button once to get into the menu.

Display: 0-N
 1-Y

0

→When the setting does not need to be reset, press and hold FEED button to return to the previous menu.

- Press the MODE button 6 times to switch the menu item--Prior Menu.

→Press the FEED button once to return to the prior menu.

Display: 1 Self Test
 2 System Setting
 3 Exit Menu

- Press the FEED button once to enter the menu item--Self Test

Display: 1 Print
 2 MSR
 3 MSR Key Inject
 4 Hex Dump Mode
 5 Previous Menu

→Press the FEED button once, you will see present "Press Feed To Print" in the LCD, press FEED button, the new settings will be printed.

If the settings were not configured correctly, follow the above procedure to configure the settings again.

Menu Setting Table

First-level menu	Second-level menu	Third-level menu	Default
1 Self Test	1 Print	Press Feed To Print	--
	2 MSR	Please Swipe Card.	--
	3 MSR Key Inject	Please Inject Key	--
	4 Hex Dump Mode	Hex Dump Mode	--
	5 Previous Menu	--	--
2 System Setting	1 Density	0-Low 1-Medium 2-High 3-Special	1
	2 Standby Time	Standby Time: [0010-9999(Sec)]	60 Sec
	3 Auto Off Time	Auto Off Time:[0000-9999(Min)]	120 Min
	4 Paper Type	0-Receipt 1-Label 2-BM(2inch) 3-BM(3inch)	0
	5 Language	0-EN 1-CH	0
	6 Factory Reset	0-N 1-Y	0
	7 Prior Menu	--	--
3 Exit Menu		--	--

NOTE: Please subject to the actual menu setting, this menu setting is only for reference.

2.5 Belt Clip

2.5.1 Install the Belt Clip

Follow the procedure below to attach the belt clip to the printer.

1. Make sure that you are attaching the belt clip in the right orientation, then screw the screw that comes with the belt clip into the designated screw hole to attach the belt clip to the printer.
2. Use a screw driver to firmly screw in the screw.

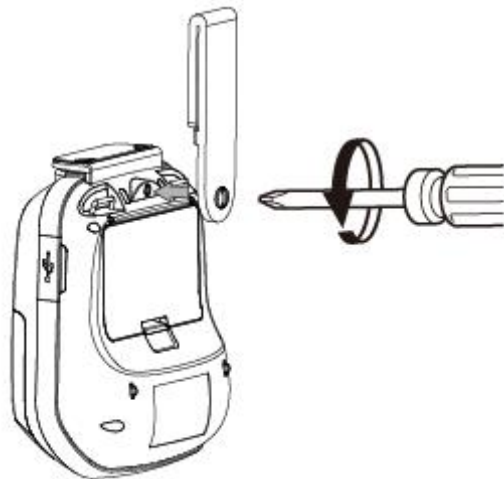

2.5.2 Using the Belt Clip

When the printer is attached to your belt, you can use it like the picture below.

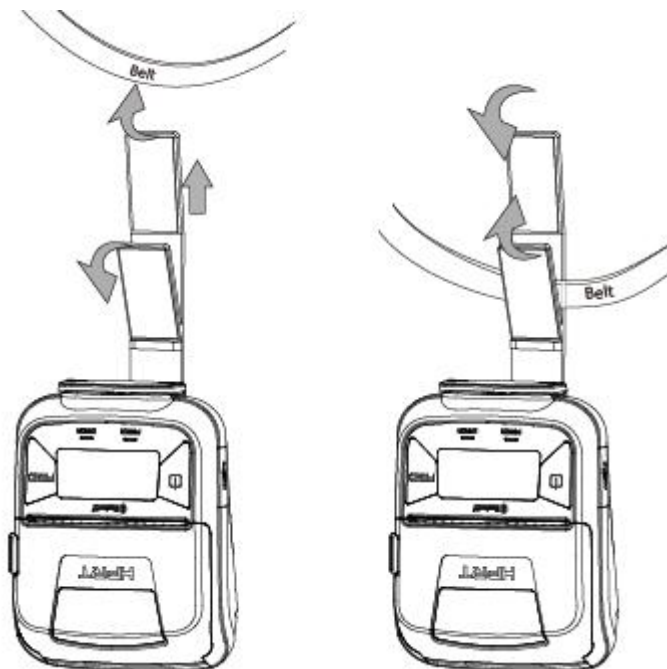

Note: *Be careful not to drop when use a belt clip. Velcro be securely fixed.*

Hold the printer firmly with your hand when you swipe a magnetic stripe card or cut paper. If it is not held firmly, you may fail to read card data or cannot cut paper smoothly with the tear bar.

3. Printer Features

3.1 Control Panel

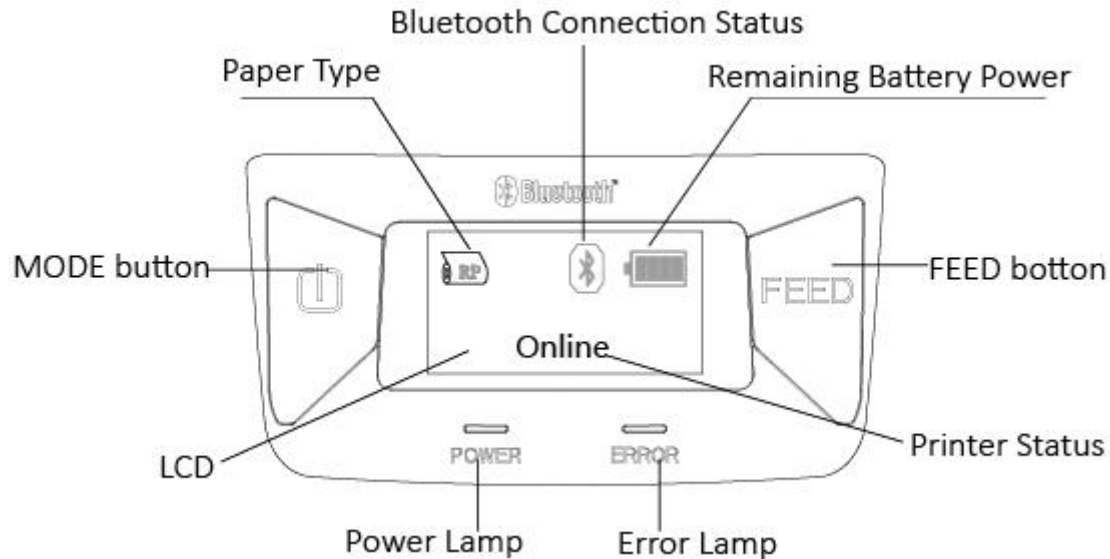

3.1.1 Button

1) MODE Button:

- ① Pressing and holding the MODE button for 2 seconds or more will turn the power on or off.
- ② Pressing and holding MODE & FEED buttons for 5 seconds will put the printer into Menu Setting mode. The MODE button can now be used to change Printer MODE status visible on the LCD screen for fast configuration.

(Refer to 2.4 Menu Settings for details about mode conversion)

2) FEED Button:

- ① When the printer is on, paper can be feed manually by pressing and holding the FEED button for more than one second.
- ② In Menu Setting mode, the FEED button can be used to move cursor(“_”) and confirm the new setting.

3.1.2 Panel Lamp

- 1) **POWER (Green)**: Printer is ON and ready to receive data.
- 2) **ERROR (Red)**: Indicates an error has occurred. (Eg: Paper Out, Cover Open, etc)

Power lamp (green)	Error lamp (red)	Status
Flash	OFF	Power-on charging
Flash	OFF	Power-off charging
ON	OFF	Power-on charging, Battery full
ON	OFF	Power-off charging, Battery full
ON	OFF	Power on
Flash	OFF	Standby
ON	Flash	Paper out
ON	Flash	Cover open

3.1.3 LCD Indication

LCD will display most of the printer status.

- 1) The 128 x 64 dots display shows alphanumeric characters.
- 2) Content

Mode/Status: Indicates the currently specified printer mode or error status.

Remaining battery power:



There is sufficient remaining battery power.



The remaining battery power is low. Please charge the battery pack.



The remaining battery power is extremely low.

Flashing Stop using the printer immediately, and charge the battery pack.

Note: If you continue printing at the low remaining battery power status, the printer cannot feed paper properly and may print with condensed (narrow) line spacing.

Bluetooth connection status



The mark on the left indicates that there is no Bluetooth connection.



The mark on the left indicates that there is a Bluetooth connection.

Paper type



Receipt



Out of paper

3.1.4 Buzzer Description

Buzzer	Status
No ring	Low battery
Once	Begin charging/Press button/Cover close
Twice	Paper out/Cover open
Three	USB disconnected

3.2 Self Test

You can use self test to check the printer's settings.

Before you start the self test, make sure that roll paper has been properly loaded into the printer.

3.2.1 Self Test Procedure

- 1) Turn on the power while holding down FEED button.
- 2) The printer will print the current printer status, including the firmware version, WiFi and Bluetooth information, barcode information.
- 3) The self test will finish automatically. The printer will be ready to receive data after the self test finishes.

3.2.2 Printing the Bluetooth Device Name and Barcode Information

Follow the procedure in section 3.2.1 to perform a self test.

```









System : HM-E300
Firmware : 1.00.00 MSR
Build date : Dec 7 2016
Build time : 14:10:25

S/N: XXXXXXXX
PrintDensity : Medium
BatteryVoltage : 8.35 V
StandbyTime : 60 Sec
PowerDownTime : 120 Min
PAPER : Receipt

[Wifi Configure]
Wifi mode : ap
SSID : 8711af_ap
Encryption : 12345678
IP address : 192.168.1.1
Subnet Mask : 255.255.255.0
MAC Address : a0:2c:36:f8:15

[Bluetooth Configure]
Name : HM-E300
Addr : 34-81-F4-1A-6D-05
Simple Pairing : Disable

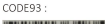
[Install Fonts]
ID Font Name
0 SYSTEM 12x24
10 CODEPAGE : PC437[U.S.A., Standard Europe]

[Barcode Samples]
UPCA :

075678 164125
UPCE :

425261
EAN8 :

0421 0009
EAN13 :

6901028075831
CODE39 :

* 1 2 3 4 5 6 7 8 9 *
ITF :

9 8 7 6 5 4 3 2 1 0
CODABAR :

A 4 0 1 5 6 B
CODE93 :

□ 1 1 E 5 1 9 3 □
CODE128 :

H 1 5 1 5 2 5 3
QR code:

[ASCII Samples]
!"#$%&'()*+,-./0123456789:;<=>?@ABCDEFGHIJKLMNO
PQRSTUVWXYZ[\]^_`abcdefgijklmnopqrstuvwxyz{|}~
Selftest Finished.
    
```

Self-Test Information

Wifi and Bluetooth Device
Name and Font Information

Barcode Information

NOTE: Please subject to the actual self-test page, this self-test page is only for reference.

3.3 Instruction for Standby(Sleep) Mode

The printer in the Standby(Sleep) Mode will recover to the Print Ready Mode when receiving print data or button operations.

Press the FEED button or the MODE button and confirm that the LCD is turned on. When the LCD is not turned on, it is possible that the printer is turned off by the Power OFF mode. In this case, turn the printer on manually.

3.4 Magnetic Card Reader

Please keep the following points in mind when reading a card.

- Swipe the card with its magnetic stripe side towards the printer.
- Hold the card in the center and swipe it straight at a steady speed in the directions of arrows. You can swipe the card in either direction to read the data.
Be sure to hold the printer firmly with your hand while swiping.

➤ *Pay attention to the hand you hold the printer, your finger should not touch the cover of the MSR slot, if not, the card cannot be read properly. (See correct example on Figure 3.4-2)*

If you hold the corner of the card, it is difficult to swipe it straight so that you may fail to read the card data. So hold the card in the center when you swipe the card.

Figure 3.4-1

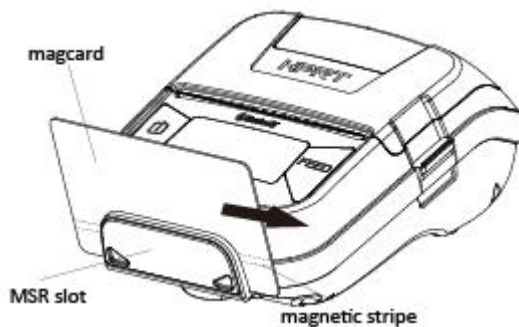

Figure 3.4-2



- A buzzer will sound once when a card is successfully read, and you will see present "MSR read success" in the LCD.
- When the printer fails to read the card, the buzzer will sound three times and you will see present "MSR read failure" in the LCD. Please check the orientation of the card, and slide it through the reader slot again.

Note:

1. Swiping JIS card is also under MSR mode.

2. JIS card operation is same as MSR card operation.

■ **Correct example:**

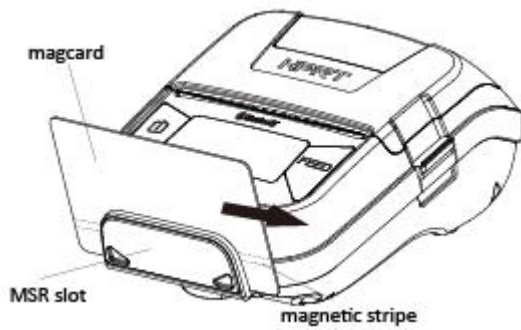

Make sure the magnetic stripe is towards to the magnetic head. Hold the card in the center as illustrated below and swipe it straight at a steady speed in the direction of arrows.

Incorrect example:

To grasp a magnetic card

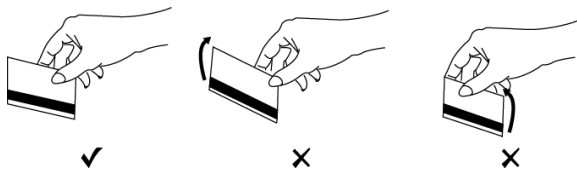

If you grasp the front/rear part of a card and move it through the MSR slot, the front /rear part is loose and a read error occurs.

To move a magnetic card



If you insert a card tilted upward/downward into the MSR slot, the card does not move horizontally and a read error occurs.



If you extract a card at the end of the MSR slot by lifting up or lowering down, the card is not maintained and a read error occurs.



If you insert a card into the middle part of the MSR card, the card is not read correctly and read error occurs, or if you move the card back or forth by force after inserting into the MSR slot, the card is not read correctly and a read error occurs.

4. Paper

4.1 Paper Specification

Paper type	Thermal paper
Paper width	80mm
Paper thickness	$0.053\text{mm} \leq X \leq 0.12\text{mm}$
Roll paper diameter	Max.50mm

4.2 Recommended Paper

Manufacturer	Product Name
Mitsubishi Paper Mills Limited	P220AG
Oji Paper Co., Ltd.	PD450
Appvion, Inc	Alpha 400-2.1
Oji Paper Co., Ltd.	FD200
Oji Paper Co., Ltd.	PD160R-63

4.3 Printing Range

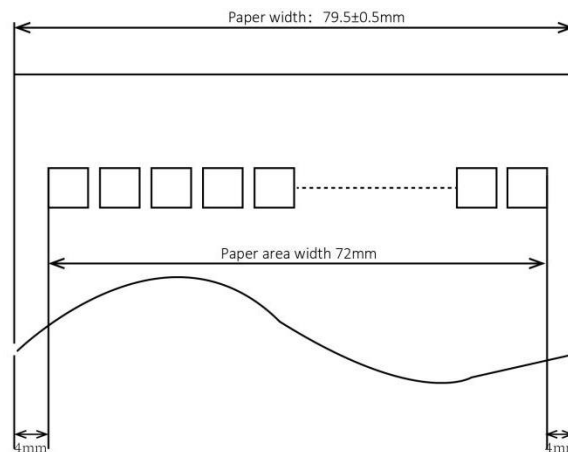

CAUTION

- 1) Do not use roll paper whose end is glued to its core, because the printer will be unable to properly detect the end of the paper. Also, we recommend that you use roll paper that has a roll end mark at its end.
- 2) Chemicals and oil may cause the roll paper to change color or cause the printed characters to become lighter.
- 3) Please be aware that the roll paper can be affected by heat, humidity, and direct sunlight.
- 4) The roll paper may change color if you scratch it with your fingernail, a hard piece of metal, etc.

4.4 Specification of Black Mark

HM-E300 supports black mark on both sides of the paper and the specification of black mark is illustrated by the following image.

● Thermal paper

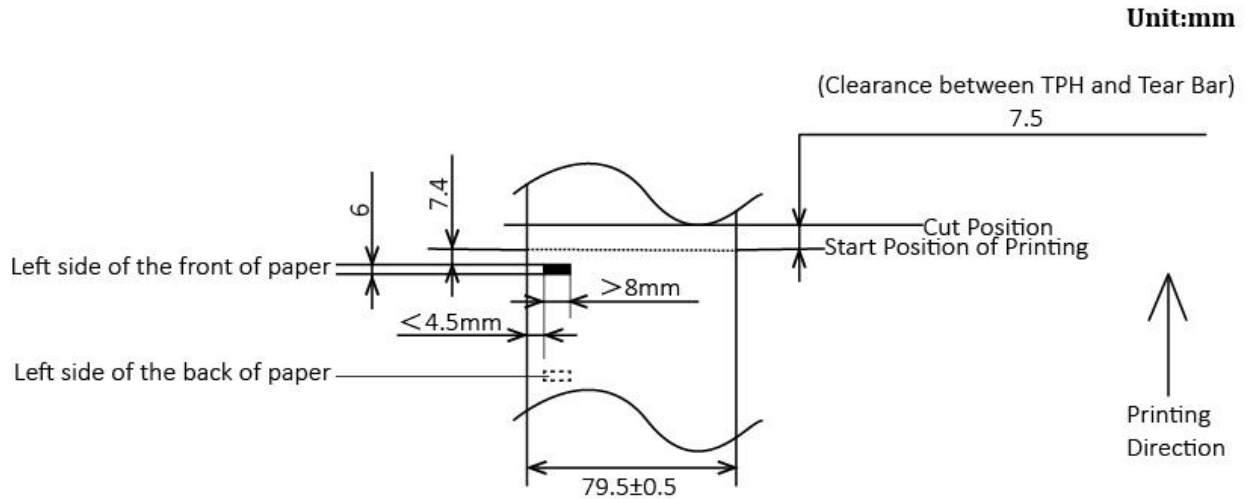

● Label paper

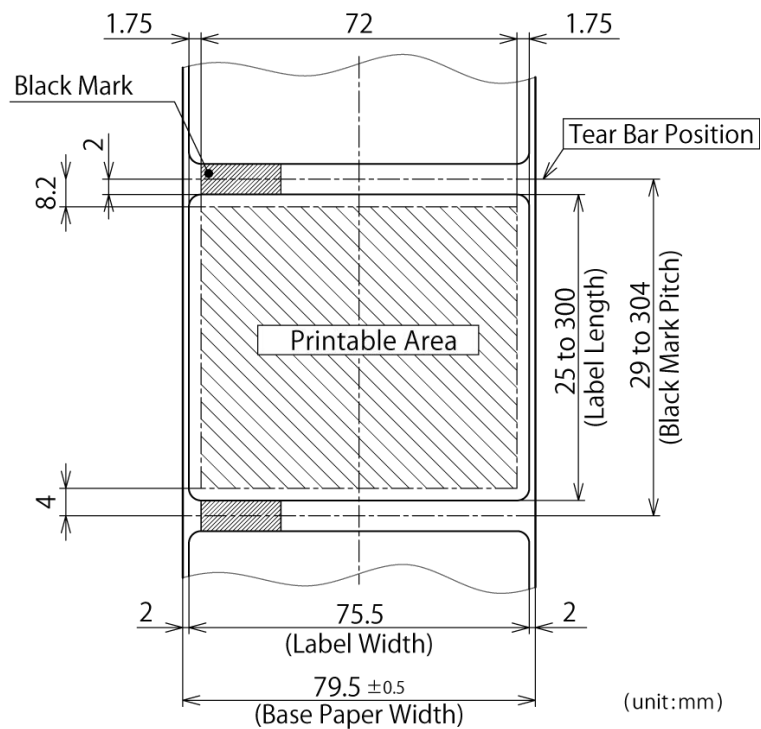

Note:PCS value of BM should be more than 0.9

5. General Specification

Table 5-1 General Specification

(1/2)

Item		Specifications	
Printing	Printing method	Direct line thermal printing	
	Resolution	203dpi (8dots/mm)	
	Printing speed	Max.70mm/s	
	Valid printing width	72mm (576dots)	
Interface	Bluetooth	Bluetooth Spec	Bluetooth Ver 3.0/4.0 [BLE] Dual Mode
		Frequency range	2.4GHz ISM band
		Data transmission rate	115200bps adjustable
		Data bit	8 data bit fixed
		Parity bit	No parity fixed
		Stop bit	1 stop bit fixed
		SSP	Compatible
		USB, Bluetooth, Wifi (Optional)	
Power saving	Sleep mode	YES	
Memory	Flash	4MByte	
Character Set	Font	Alphanumeric: 9x17, 12x24 dots Kanji:24x24 dots	
Barcode Symbologies	1D	UPC-A, UPC-E, EAN8, EAN13, CODE39, ITF, CODE128, CODE93	
	2D	QR code, PDF417	
Graphics		Support bitmap printing with different density and user defined bitmap printing	
Detection	Sensors	Printer cover open sensor, Paper-out sensor, Black mark sensor, Label gap detection	
LED lamp	Power lamp	Green	
	Error lamp	Red	

Table 5-1 General Specification(Continued)

(2/2)

Item		Parameter
Charging	USB charge Output DC 5V $\overline{\text{---}}$ 1A	
Power supply	Battery	2300mA 7.4V rechargeable battery pack
	Battery operating time	keep working for about 2 hour(printing full lines of characters)
LCD		128 x 64 dots with Blue Backlight
MSR (Single Head)	Format	ISO 7810, ISO 7811, ISO7812 1st, 2nd and 3rd Track/ JISII Track Reading
	Security	AES or 3DES encryption. DUKPT Key Management
Paper	Paper type	Thermal paper
	Paper width	$79.5 \pm 0.5\text{mm}$
	Paper thickness	$0.053\text{mm} \leq X \leq 0.12\text{mm}$
	Roll paper diameter	Max.50mm
	Recommended paper	P220AG, PD450, FD200, Alpha 400-2.1, PD160R-63
Physical characteristics	Operation condition	-5°C to 50°C, 25% to 85%RH
	Storage condition	-20°C to 60°C, 5% to 95%RH
	Dimension	106.2(W) x 139.1(D) x 61.9(H)mm
	Weight	400g (including battery pack)
Reliability	TPH	50km(not more than 12.5% printing density)/100 million pulses
Software	Emulation	ESC/POS
	Driver	Win xp/Win 7/Win 8/Win 10/Linux
	SDK	WinCE, Win Mobile, Android, IOS, Linux

WARNING:

Please use the recommended thermal paper or same quality paper, otherwise it will influence the printing quality and decrease the thermal print head life.

Please use at a room temperature if you want to set the print density to “Special”.

Some types of the paper are not suitable for use in low-temperature environment.

■ Dimensions

- External Dimension: 106.2mm (W) x 139.1mm(D) x 61.9mm (H)
- Weight : 400g (including battery pack)

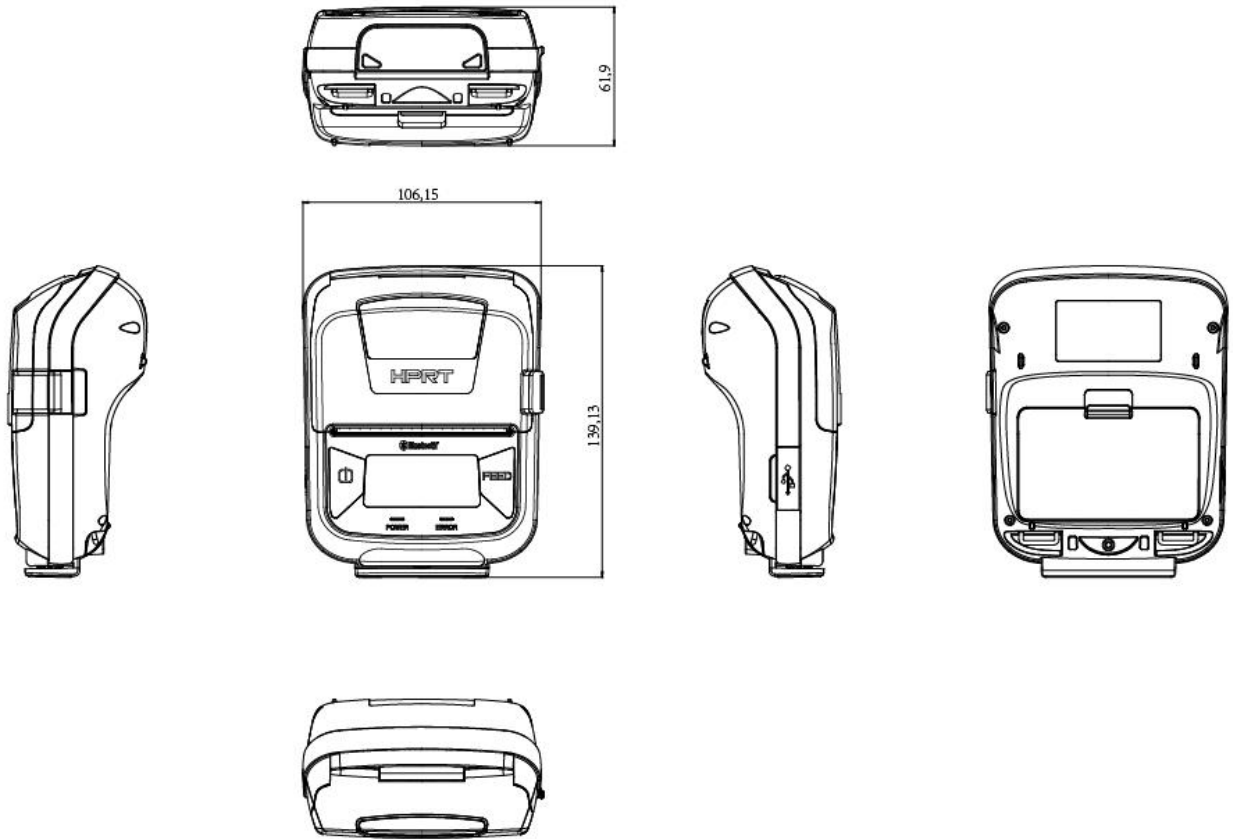

6. Detailed Specification

Item	Specification
MCU specification	MCU: 32bits RISC, FLASH : 256K bytes, RAM: 48K Bytes
Bluetooth highest frequencies	2.4 GHz
Bluetooth module basic clocking	26MHz
Bluetooth output	2.34mW (3.7dBm)

7. Interface

7.1 USB for Battery Charge

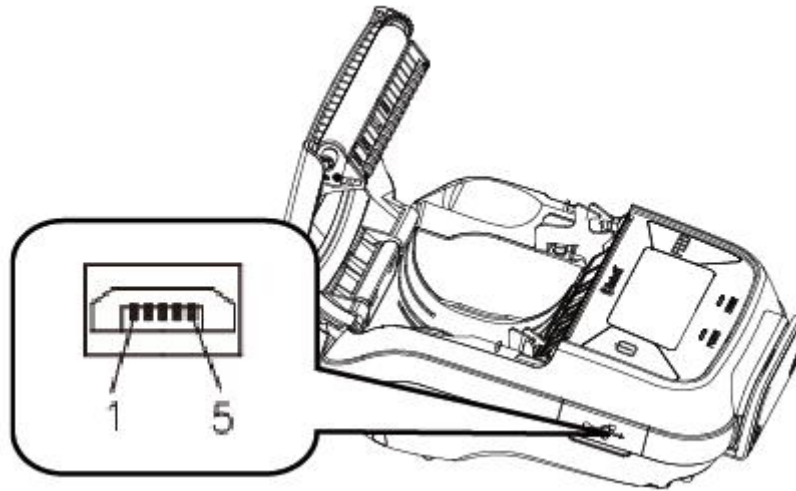

HM-E300 printer has a USB interface for Battery charging and is connected by means of 5pin micro USB socket. In the following table, the signals present on the micro USB socket are listed.

Pin No.	SIGNAL
1	VBUS
2	D-
3	D+
4	NC
5	GND

■ USB cable

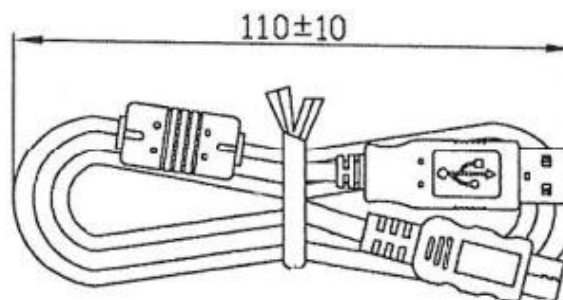

7.2 Bluetooth

Category	Specification
Bluetooth Spec.	Bluetooth Ver 3.0/4.0 [BLE] Dual Mode
Frequency Range	2.4GHz ISM band
Data Transmission Rate	115200bps adjustable
Data Bit	8 data bit fixed
Parity Bit	No parity fixed
Stop Bit	1 stop bit fixed
SSP	Compatible

PIN code: 1234 as default

Device Name: HM-E300-XXXXX

(XXXXX is the last 5 digits of the Product Serial Number)

8. Specifications of Accessories

8.1 Battery Pack

7.4V, 2300mAh

Rechargeable Lithium-ion

Safety Approvals: PSE

8.2 Belt Clip

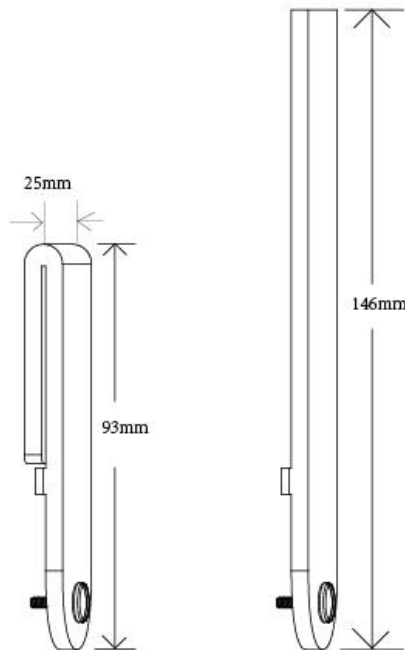

9. Troubleshooting Procedure

When a trouble occurs, confirm its phenomenon, locate a defective part in accordance with "9.1 Troubleshooting Guide", and troubleshoot as described below.

Phenomenon:

Find a trouble phenomenon in this column. If there are multiple phenomena, take all the corresponding items into consideration. This allows you to specify a hidden defective part.

Cause:

Lists as many possible causes as possible. Guess a trouble cause out of them and take its check method to specify the trouble cause.

Check Method:

Describes a check method to specify a trouble cause.

Remedy:

Troubleshoot by taking a remedy described in this column.

By troubleshooting in accordance with the above-mentioned procedure, you can troubleshoot efficiently with fewer misjudgments.

9.1 Troubleshooting Guide

9.1.1 Power Supply Failure

Phenomenon	Cause	Check Method	Remedy
No Power	The battery is not connected		Connect the specified battery
	The battery is discharged	Battery level ≤7.4V	Charge the battery

9.1.2 Printing Failure

Phenomenon	Cause	Check Method	Remedy
No printing	The roll paper is loaded upside down.		Install the roll paper properly.
	Faulty Main Logic Board Unit.		Replace the Main Logic Board Unit.
	Faulty connection of the thermal head connector.	Check connection of the thermal head connector.	Connect the thermal head cable to connector properly.
	Faulty thermal head.		Replace the Mechanism Unit.
Partly not printed	Faulty connection of the thermal head connector.	Check connection of the thermal head connector.	Connect the thermal head cable to connector properly.
	Printer cover one side close.		Close printer cover correctly.
	Faulty thermal head.		Replace the Mechanism Unit.
Faint printout or uneven printout	Level of battery voltage is low.	Check the battery lamp on the LCD.	Charge the battery.
	Printer cover one side close.		Close printer cover correctly.
	Faulty thermal head.		Replace the Mechanism Unit.
	Foreign substance is adhered to the thermal head.	Check whether any foreign substance are adhered to the thermal head.	Dip a cotton swab or soft cloth in ethyl alcohol and wipe the foreign substance with them.
	Non-recommended paper is used.	Check whether the paper being used meets the specification.	Replace it with the specified paper.
	Faulty mounting of the platen.	Check mounting condition of the platen.	Mount the platen properly.

9.1.3 Faulty Sensor

Phenomenon	Cause	Check Method	Remedy
Does not detect presence of paper.	Faulty paper sensor.	Check whether the ERROR lamp flickers when paper is out.	Replace the Mechanism Unit.
	Foreign substance is attached the paper sensor.	Check whether any foreign substance are adhered to the paper sensor.	Remove the foreign substance.
	Faulty connection of the paper sensor connector.	Check connection of the paper sensor connector.	Connect the paper sensor cable to connector correctly.

9.1.4 Paper Feed Failure

Phenomenon	Cause	Check Method	Remedy
Paper is not feed or feed irregularly	The printer cover is not closed properly.		Close the printer cover properly.
	Faulty connection of the motor connector.	Check connection of the motor connector.	Connect the motor cable to connector correctly.
	Defective motor.		Replace the Mechanism Unit.
	Battery voltage drop.	Check the battery display of the LCD.	Charge the battery.
	Faulty Main Logic Board Unit.		Replace the Main Logic Board Unit.
	Faulty mounting of the platen.	Check mounting condition of the platen.	Mount the platen properly.
	Paper feed failure.	Check whether or not the paper is jamming or torn and caught in the paper path.	Eliminate unnecessary paper in the paper path and set paper properly.
	Foreign substance in the gear.		Eliminate the foreign substance.
	Broken gear.		If the gear is broken, replace the Mechanism Unit.

9.1.5 Error Message(Printer Status indication on the LCD)

Message	Description of failure message	Remark
Cover Open	Printer cover is not closed properly.	Close printer cover properly.
Out of Paper	Empty paper.	Replace the roll paper.
High Temperature	Thermal Head is overheat.	Is recovered with the automatic which comes to be cool.

10. Windows Driver

10.1 Operating System

The following operating systems are supported for usage.

- Microsoft Windows 10 (32 bit/64 bit)
- Microsoft Windows 8 (32 bit/64 bit)
- Microsoft Windows 7 SP1 (32 bit/64 bit)
- Microsoft Windows Vista SP2 (32 bit/64 bit)
- Microsoft Windows XP Professional SP3 (32 bit)
- Microsoft Windows Server 2012(64 bit)

10.2 Windows Driver Preparation

The installation file name is HPRT Mobile Printer Driver vX.X.X.X.exe

E.g. HPRT Mobile Printer Driver v2.6.7.0.exe

10.3 Windows Driver Installation



Warning: Under different operating systems, the screen has slight differences. Please operate it according to the tips. Take Windows 7 as example.

1. Double click Windows Driver .
2. Choose "English" and click "OK".

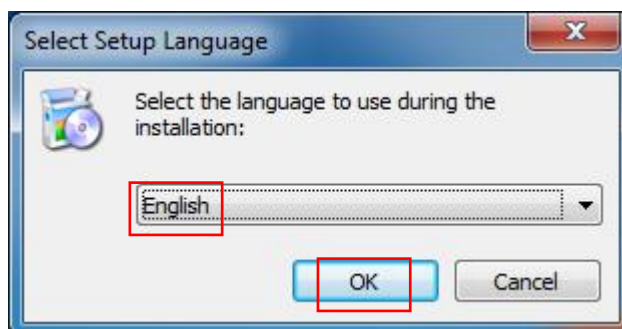

3. Choose "I accept the agreement" and click "Next".

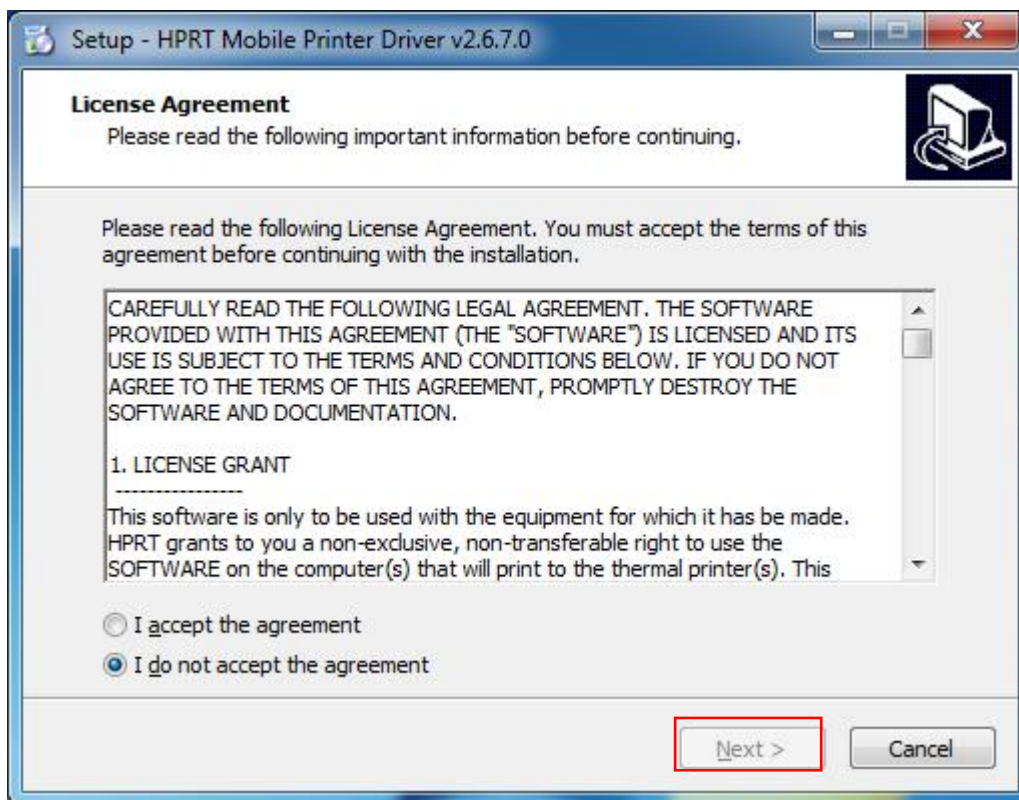

4. Click "Next".

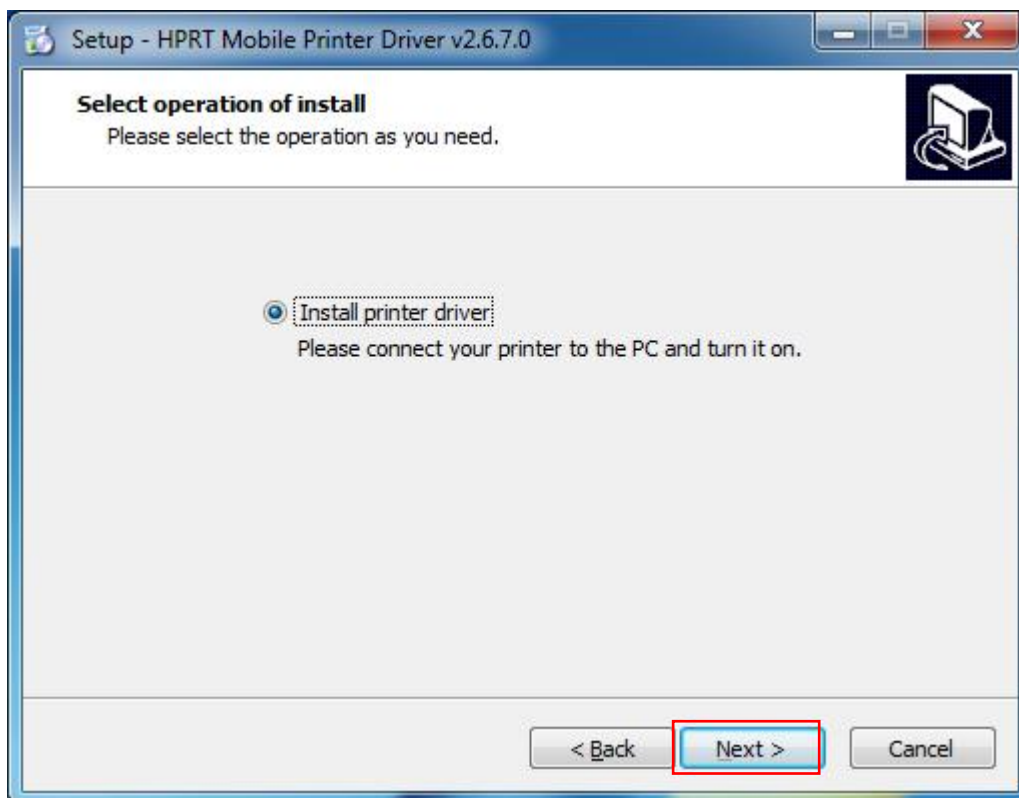

5. Choose the printer model, then choose the matched type of port (USBxxx is for USB port, COMx is for serial port, LPTx is for parallel port), and click “Next”.

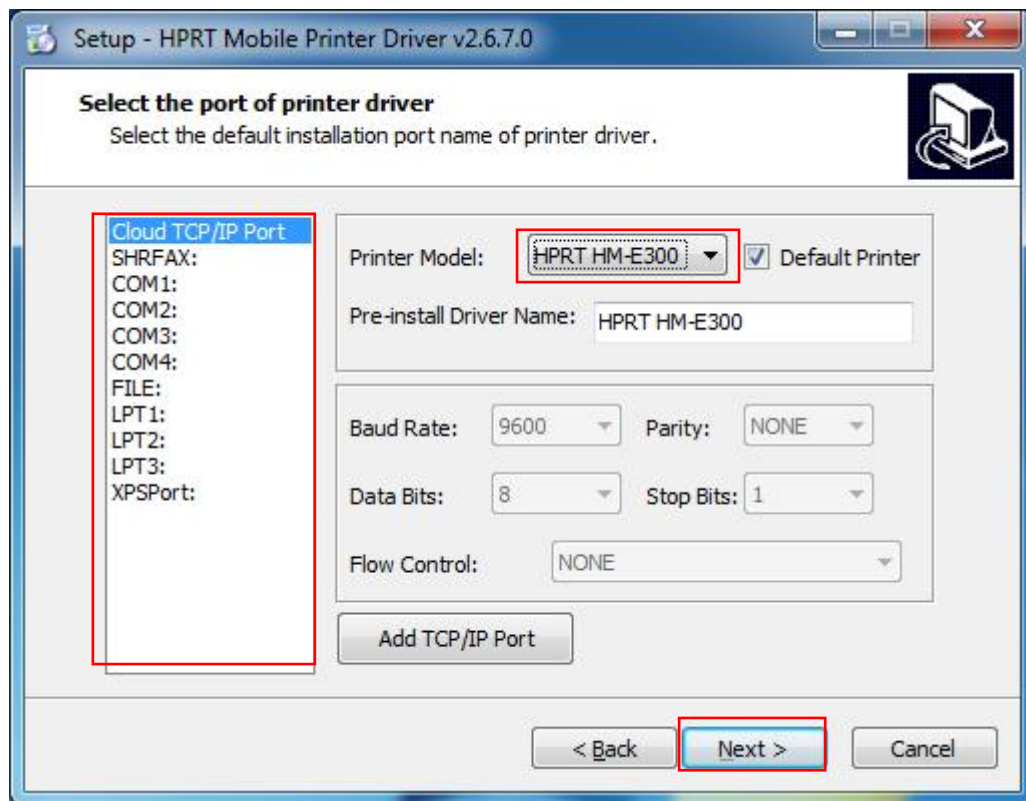

NOTE: If printer is already connected with computer by USB port, it only needs to click “Install”, then it will be installed automatically. Otherwise, proceed to the next step.

6. Finish the installation.



7. After installation, the icon will be found in "Start" → "Devices and Printers".



NOTE: If you already installed the driver (No matter what kind of port), when you connect the printer with computer, it will create a USB port automatically.

10.4 Detailed Windows Driver Setting

10.4.1 Printing Preferences

1. Click “Start” → “Devices and Printers”. Right click “HM-E300” and choose “Printing preferences”.

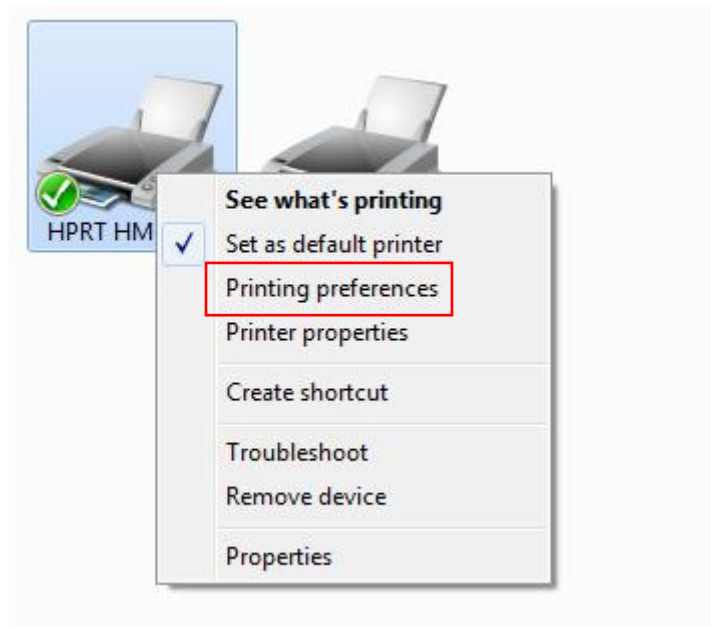

2. According to different needs, set up the paper.

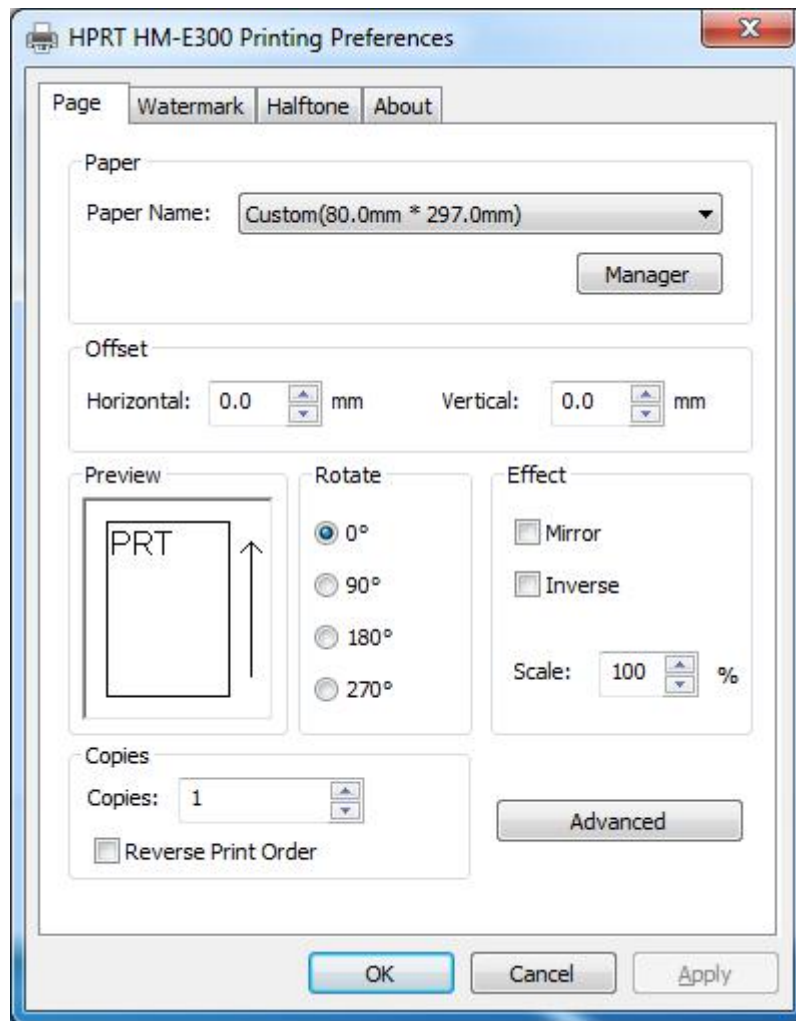

- Click “Paper Name”, and choose the paper type.

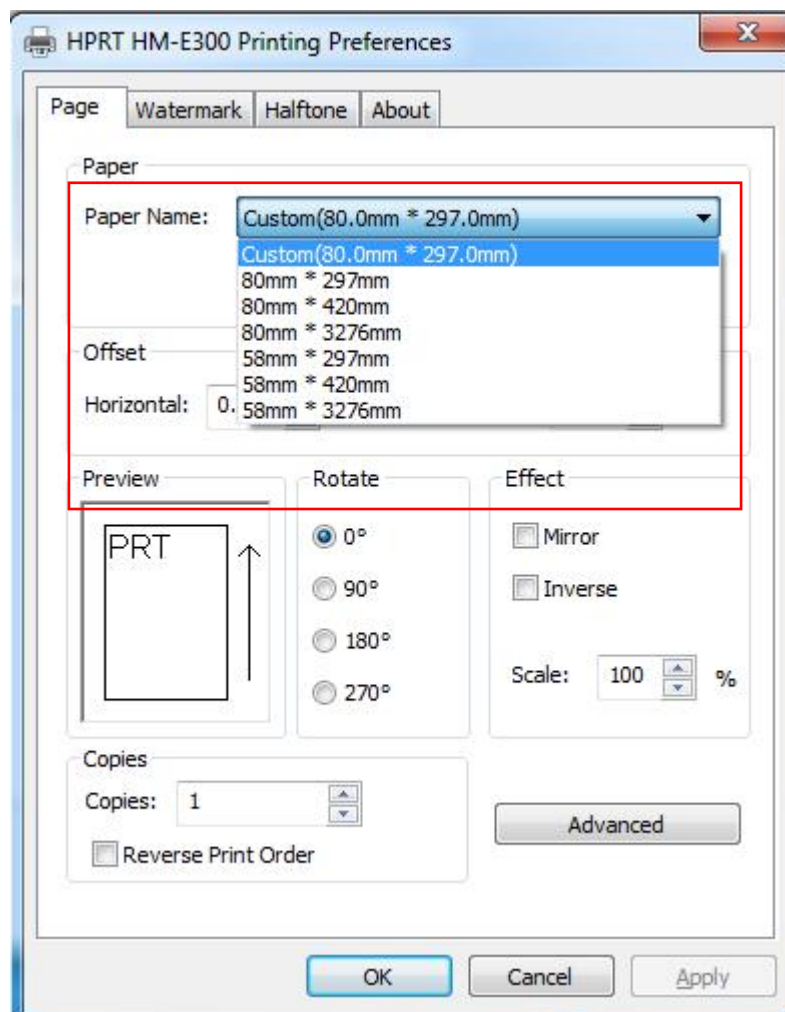

- Click “Manager”. Set up the custom paper.

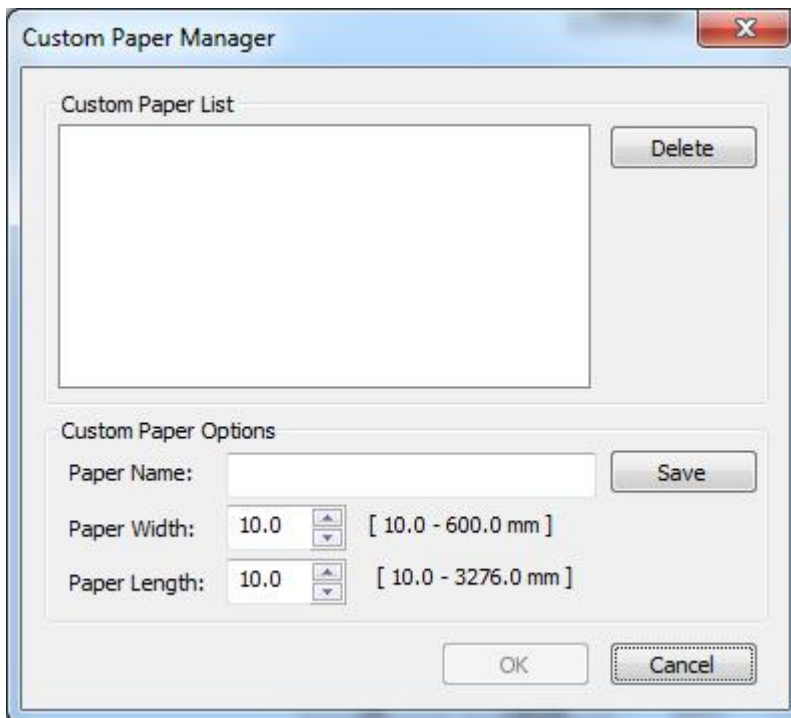
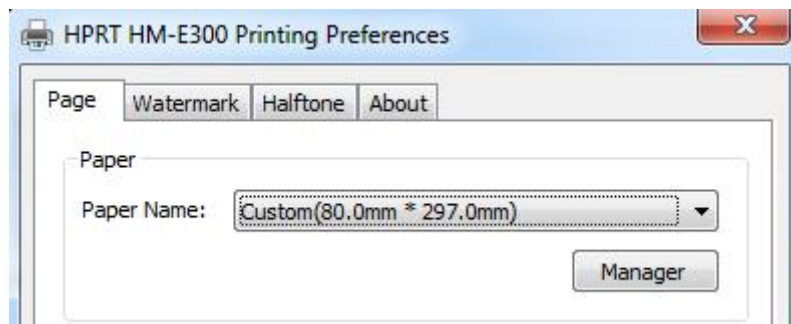

- Choose “Rotate” or “Effect”, showed in the “Preview”.

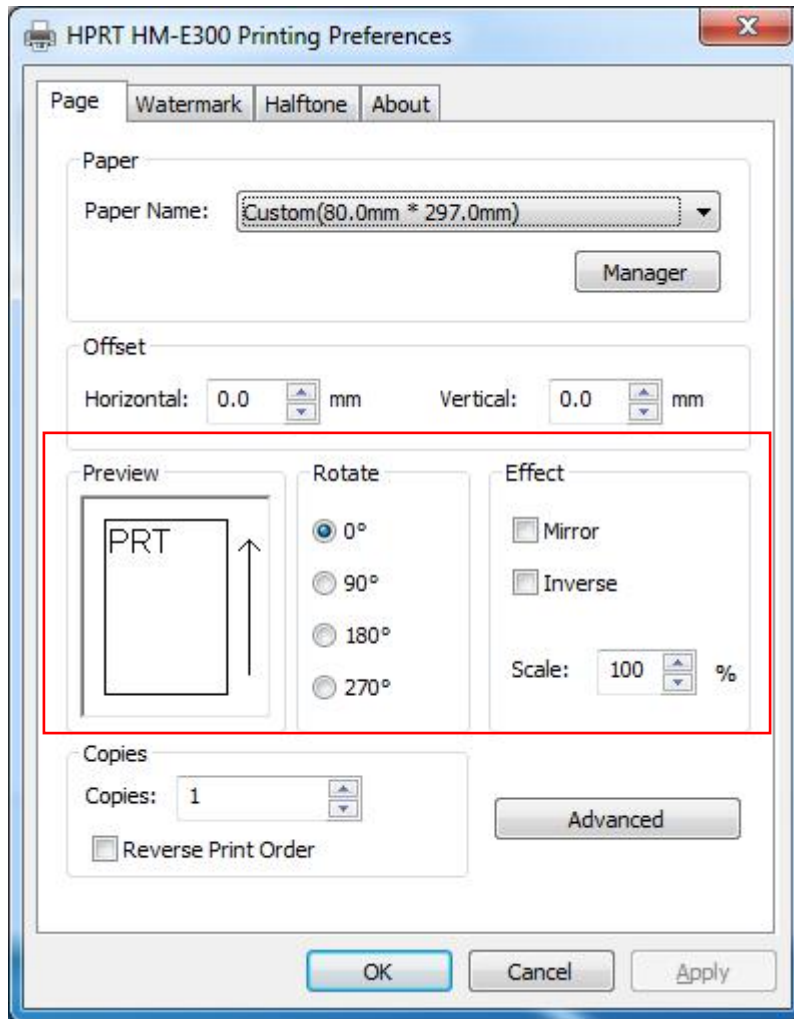

For example, choose “Mirror” effect, showed as below:

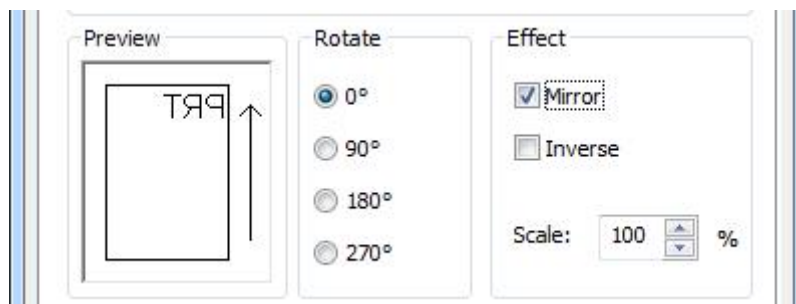

- Click “Advanced” to set up “Save Paper”, “Feed Paper”, “Custom Command” and “Media Type”.

Save Paper:

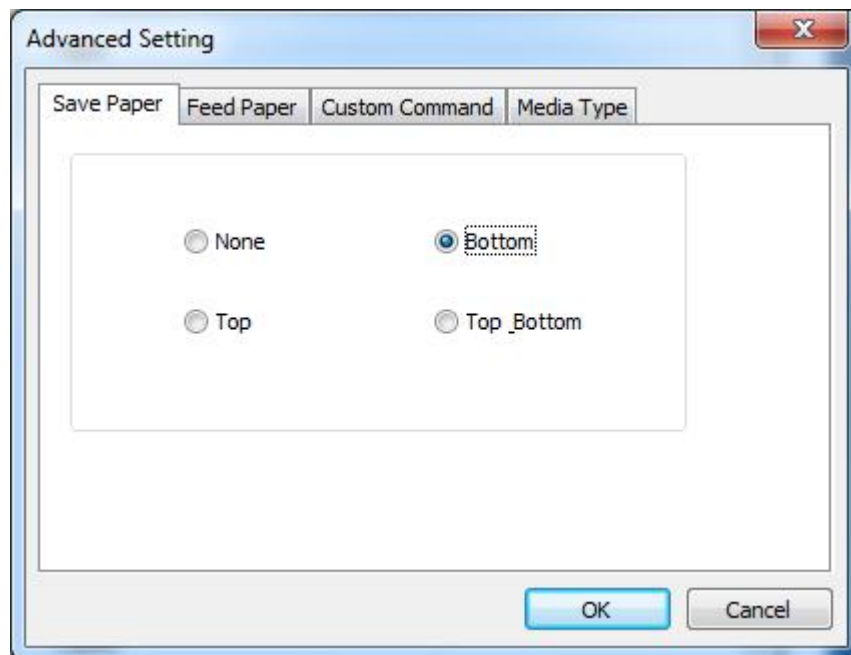

Feed Paper:

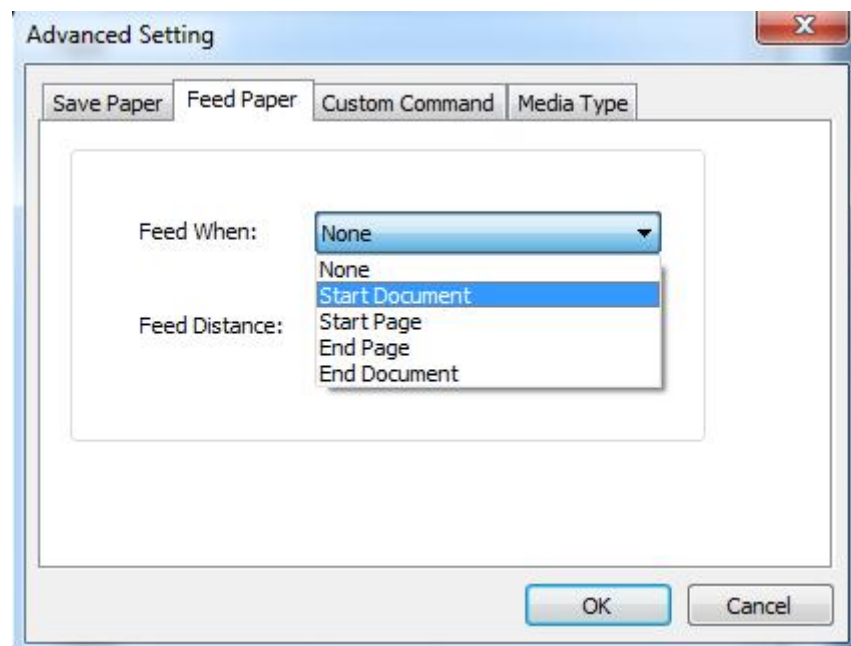

Custom Command:

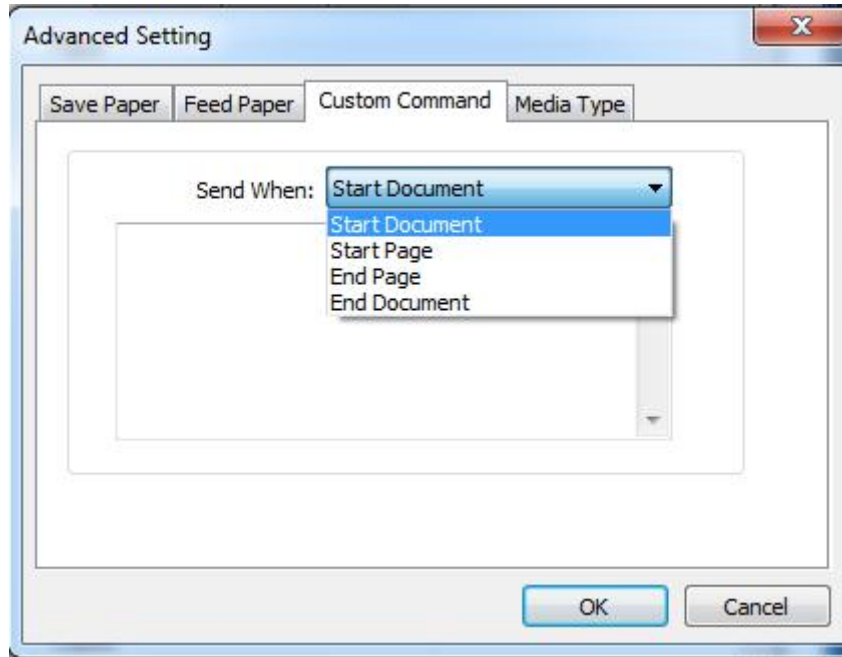

Media Type:

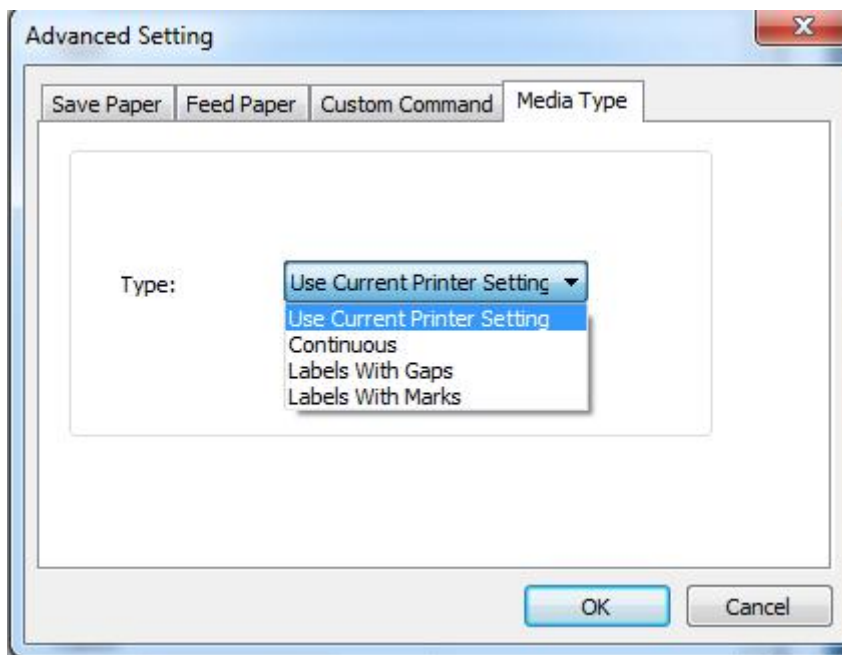

3. Set up the watermark.

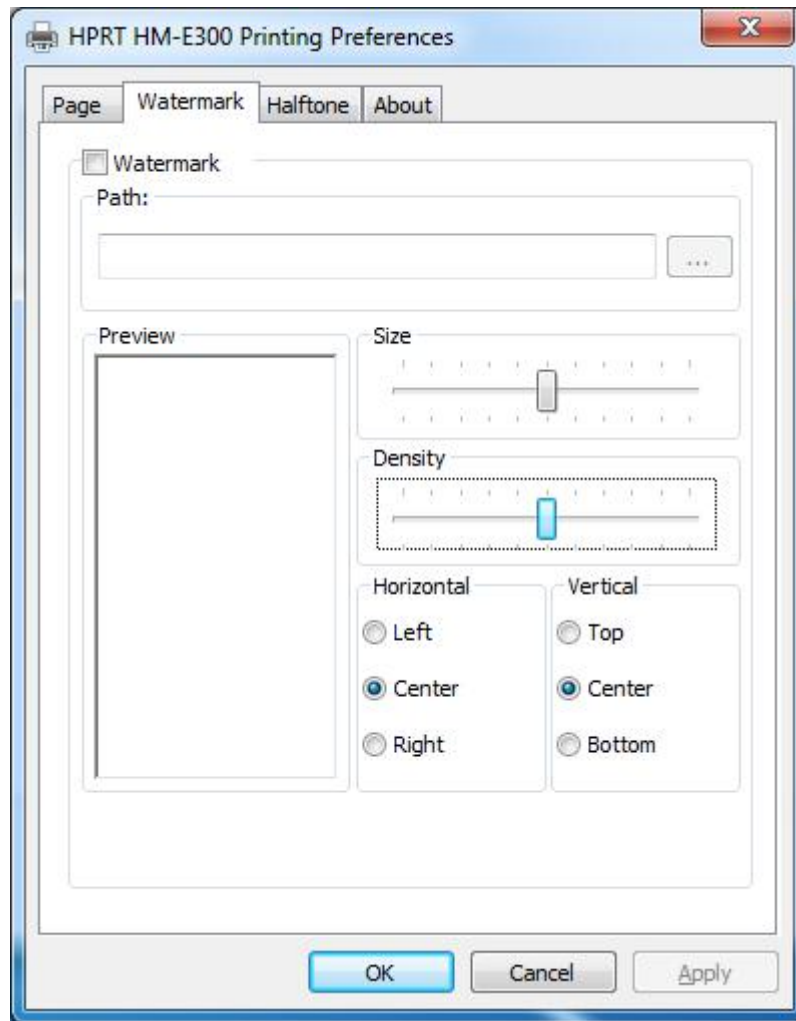

4. Set up halftone.

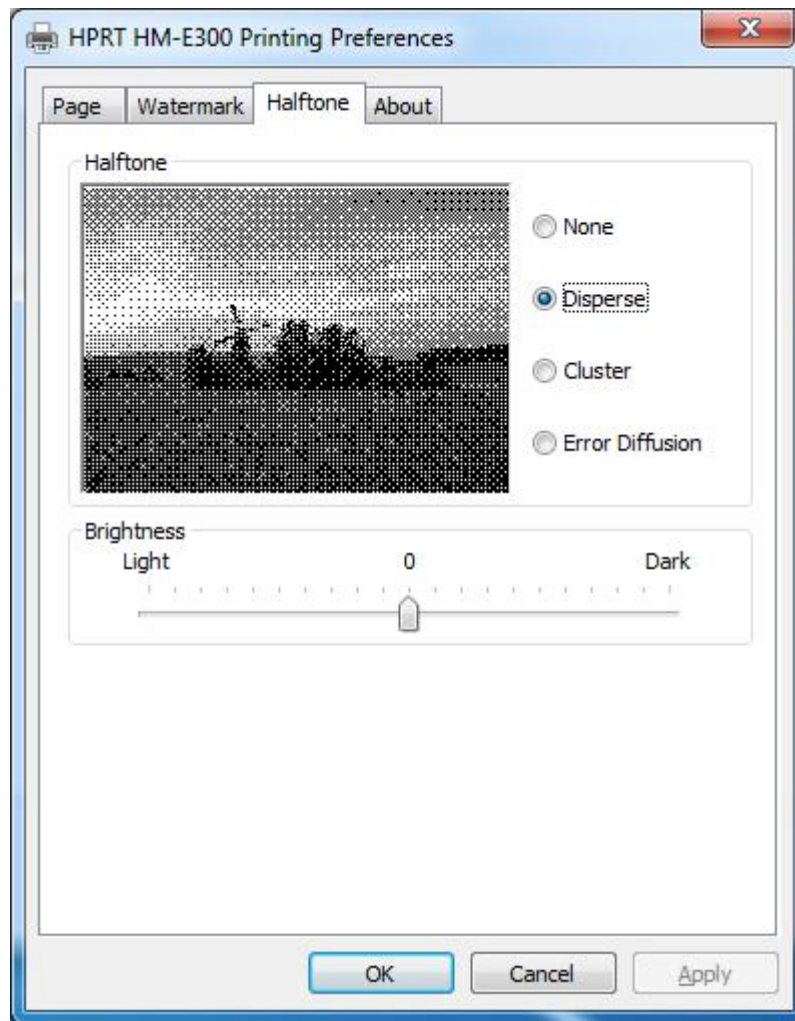

5. After finishing all the settings of printing preferences, click "OK" to save it.

10.4.2 Other Settings

1. Click “Start” → “Devices and Printers”. Right click “HM-E300” and choose “Printer properties”.

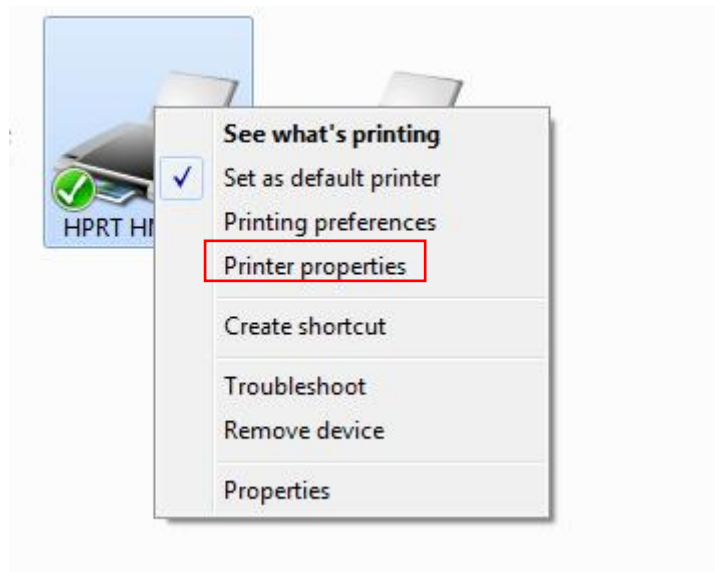

2. Click “General” → “Print Test Page”, and printer will print labels with current settings.

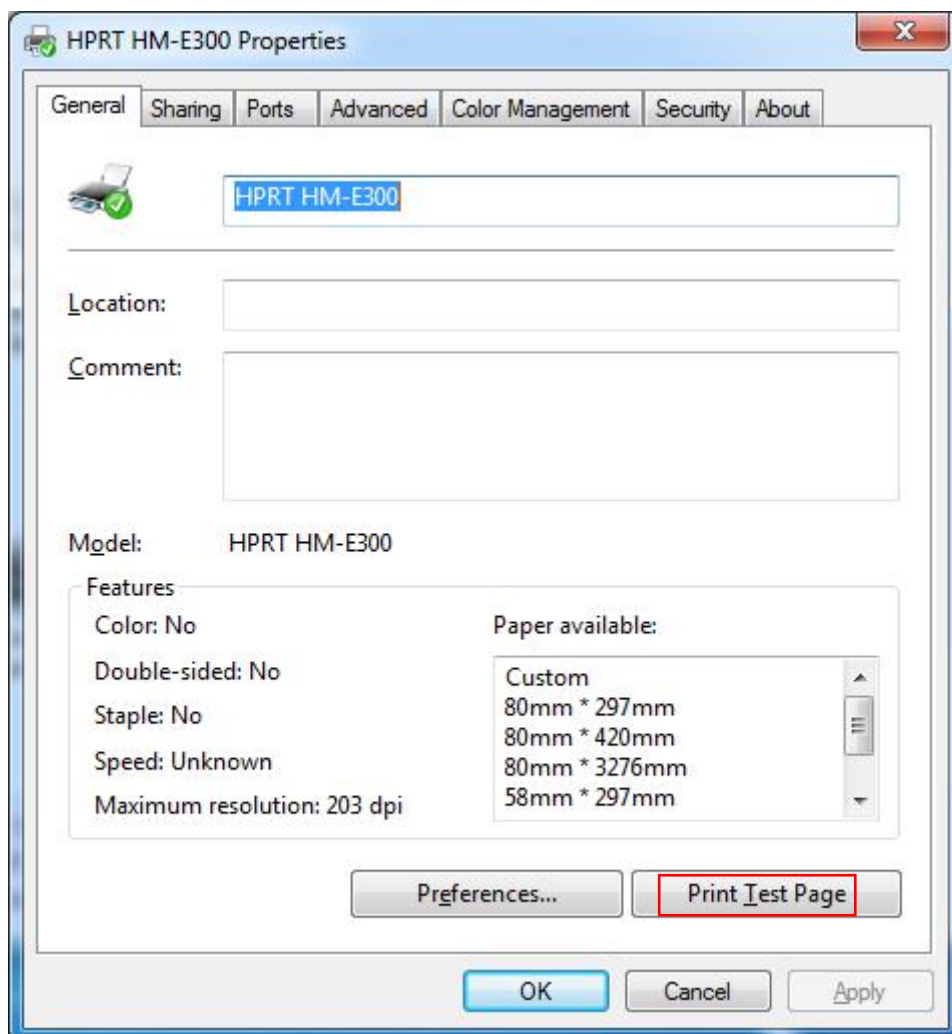

3. Click “Ports”, and choose the port needed.

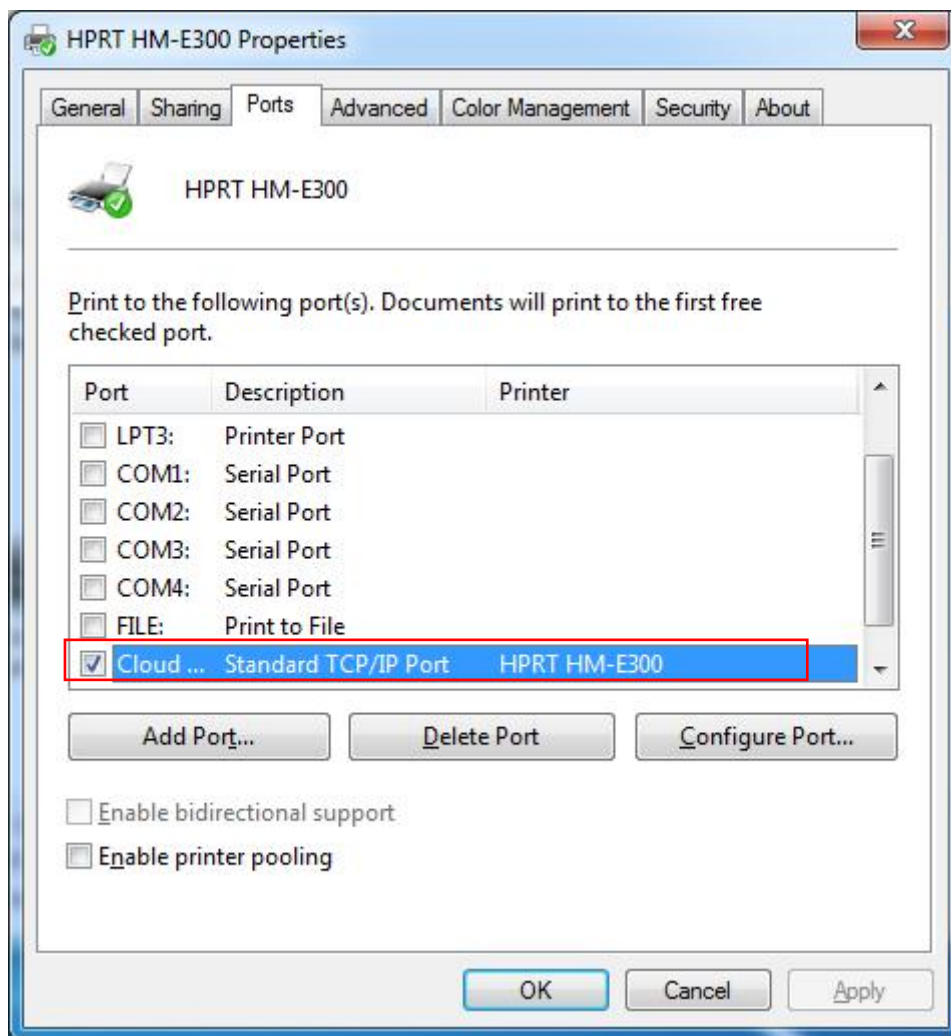

4. Click “Advanced” and set up as need.

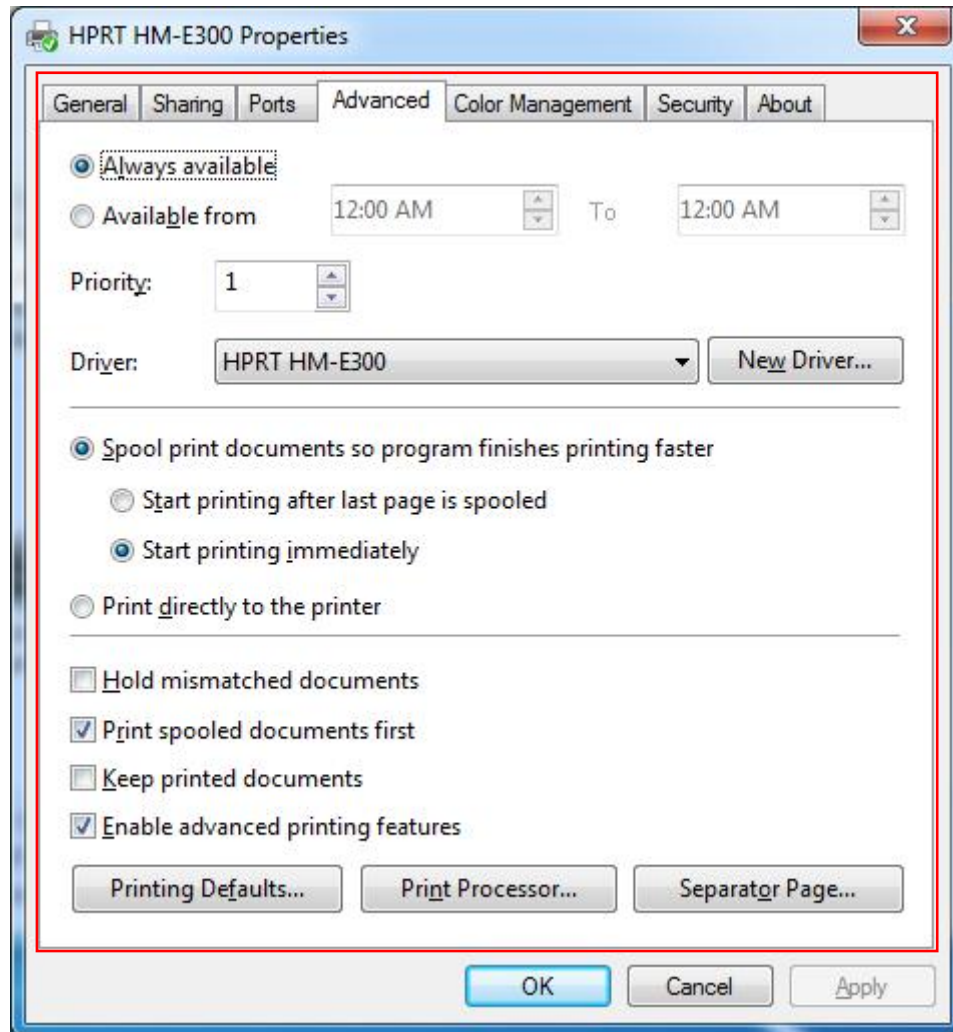

10.5 Uninstalling the Driver

1. Double click the driver icon , choose “Uninstall printer driver” and click “Next”.

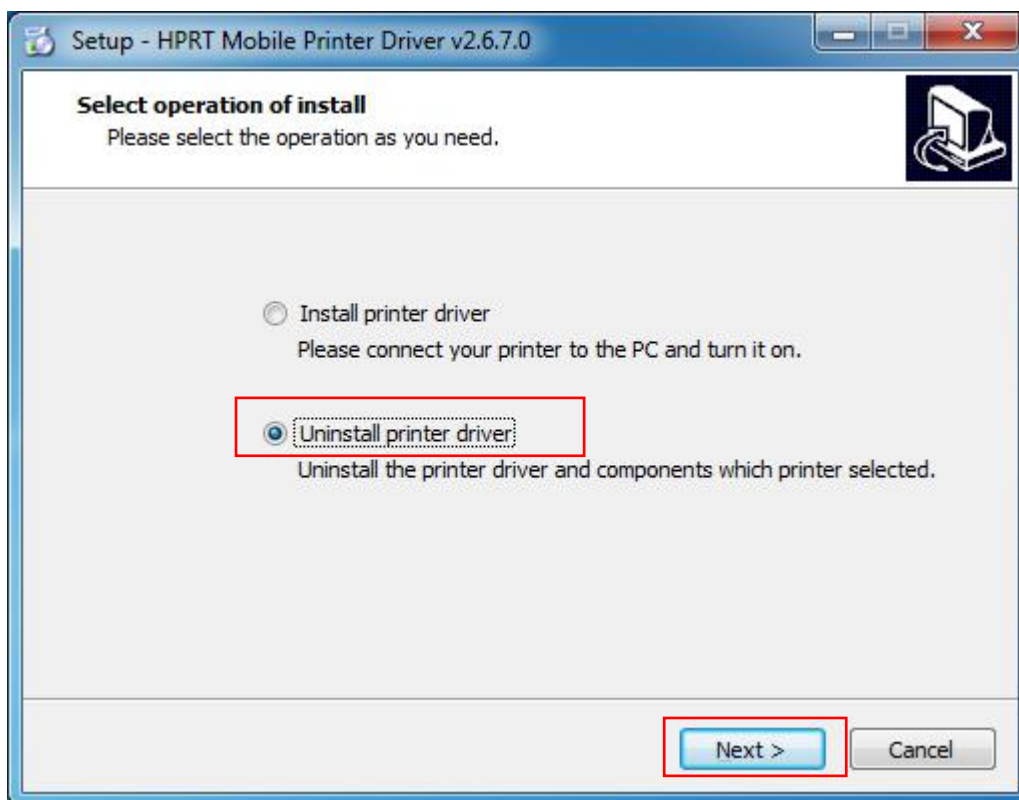

2. Click “Next”.

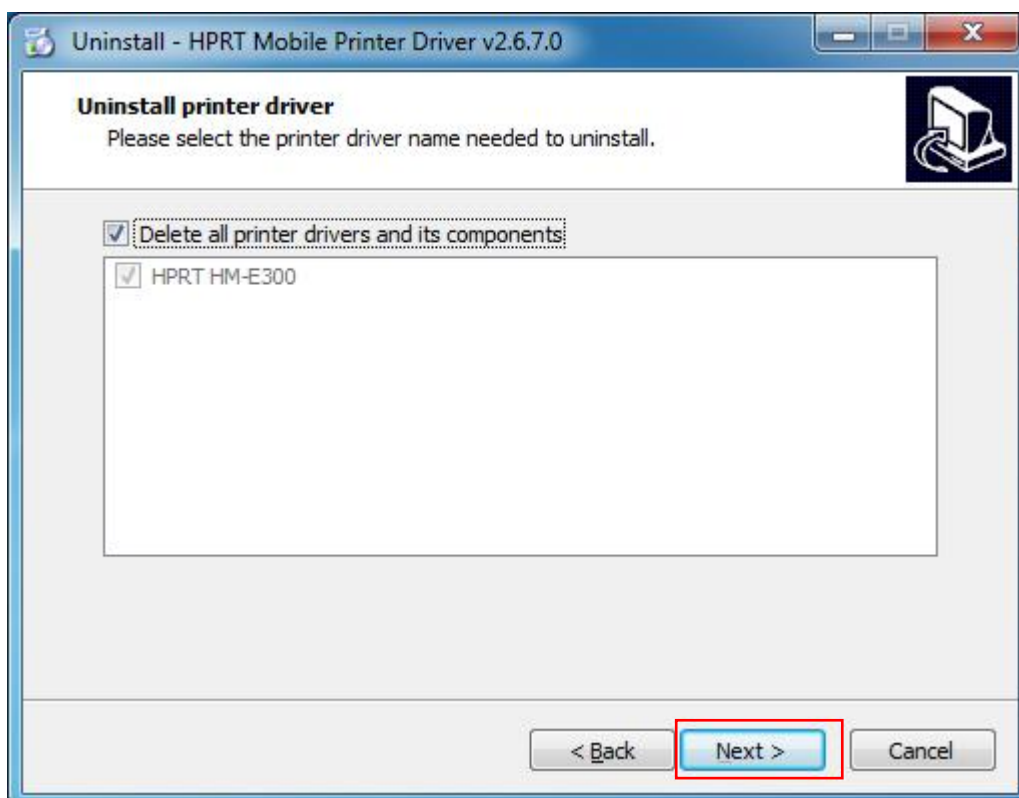

3. Choose "Yes".

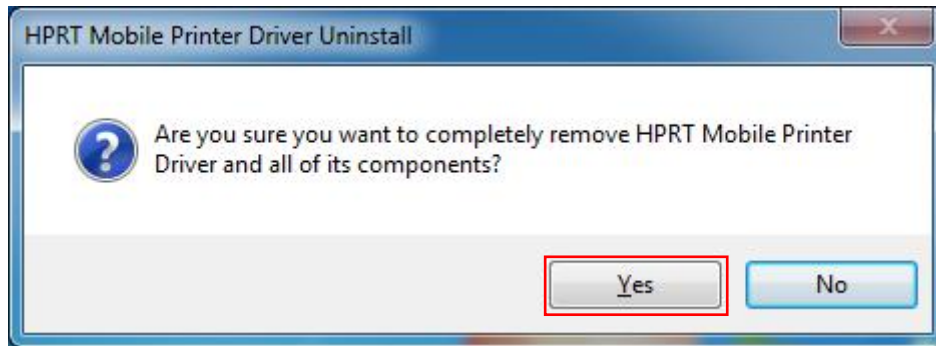

4. Click "OK" to finish uninstalling.

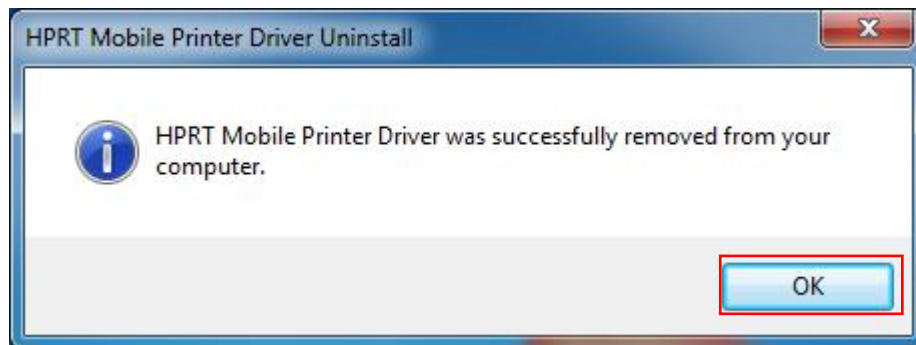

11. Utility Tool Instruction

11.1 Operating System (OS) Environment

HM-E300 Utility Tool is applicable to the following operating system:

- Microsoft Windows 10 (32 bit/64 bit)
- Microsoft Windows 8 (32 bit/64 bit)
- Microsoft Windows 7 SP1 (32 bit/64 bit)
- Microsoft Windows Vista SP2 (32 bit/64 bit)
- Microsoft Windows XP Professional SP3 (32 bit)
- Microsoft Windows Server 2012(64 bit)

11.2 Utility Tool Preparation

The installation file name is.HPRTUtilityForMobile_Dealer VX.X.X.X

E.g.HPRTUtilityForMobile_Dealer V2.0.0.11

11.3 Using Utility Tool



Warning: Under different operating system, the screen has slight difference. Please operate it according to the tips. Take Windows 10 as example.

Unzip the compressed package file, then open the folder, click  to open the Printer Utility For Mobile.

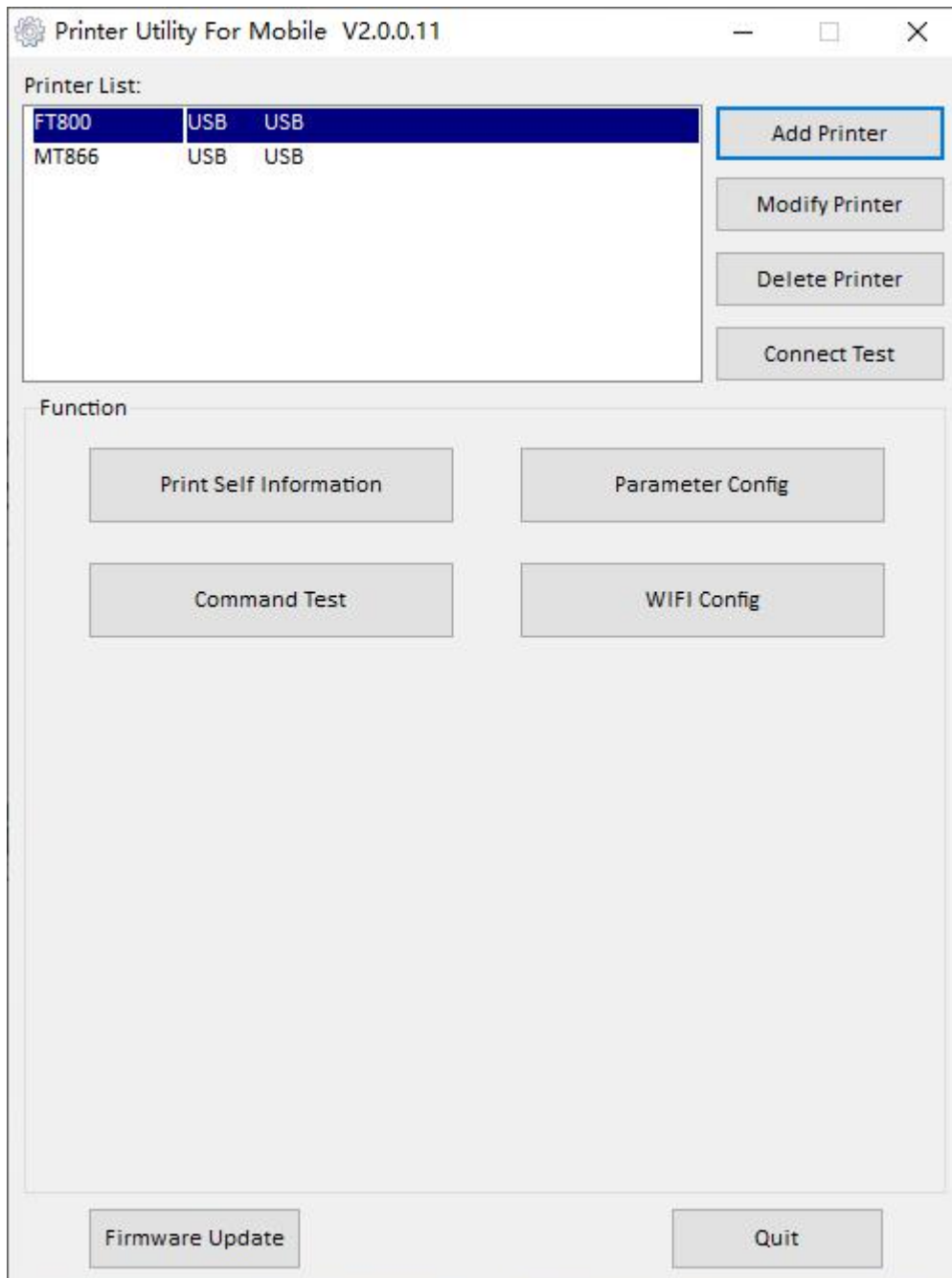

11.3.1 Add Printer

1. Click “Add Printer”.

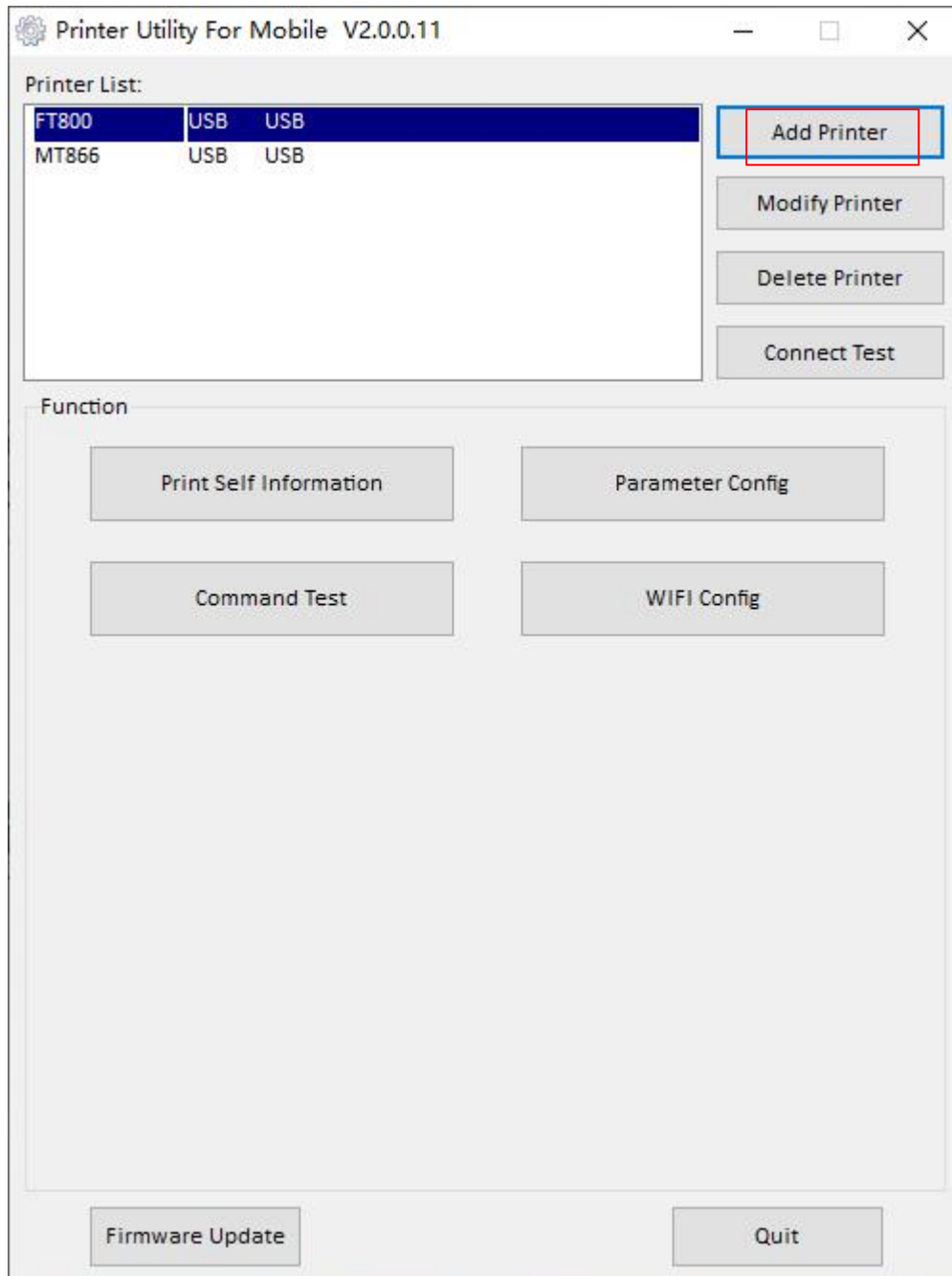

2. Choose the right printer model and port type, then click “OK”.

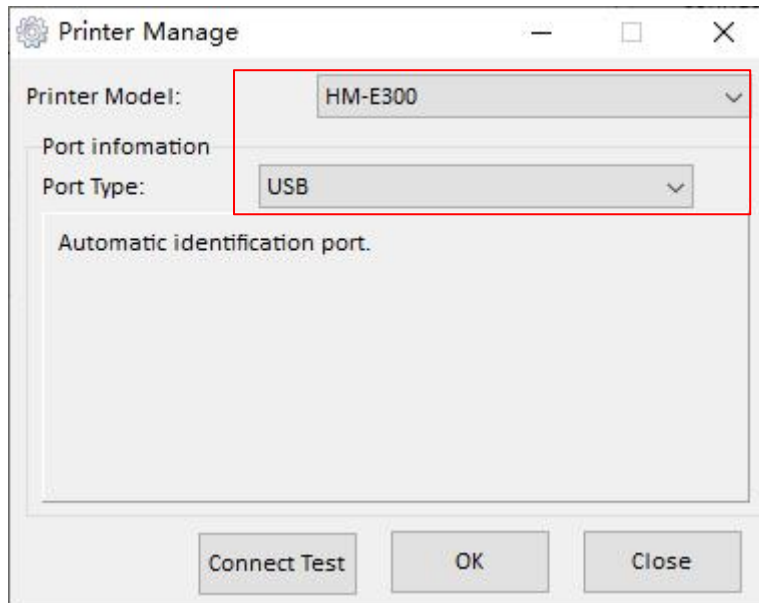

3. “Add printer” is finished.

11.3.2 Modify Printer

1. Choose the printer which you want to modify in the list, then click "Modify Printer".

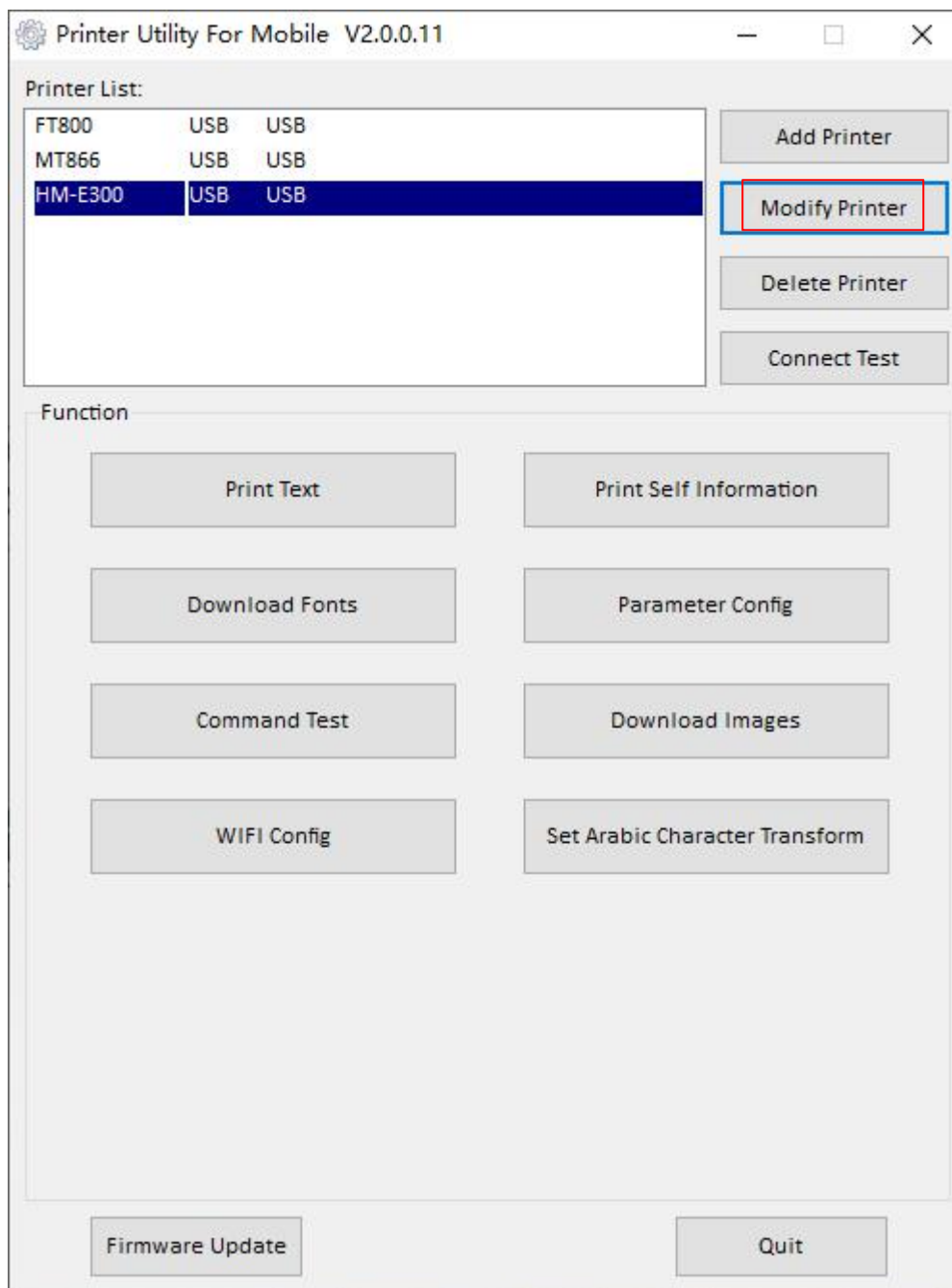

2. Choose the new model and new port, then click “OK”.

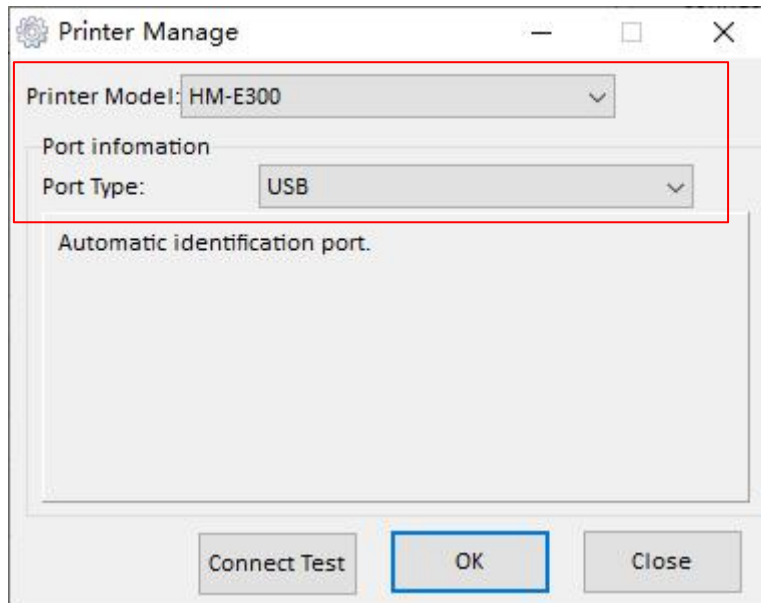

3. “Modify Printer” is finished.

11.3.3 Delete Printer

1. Choose the printer which you want to delete in the list, then click "Delete Printer".

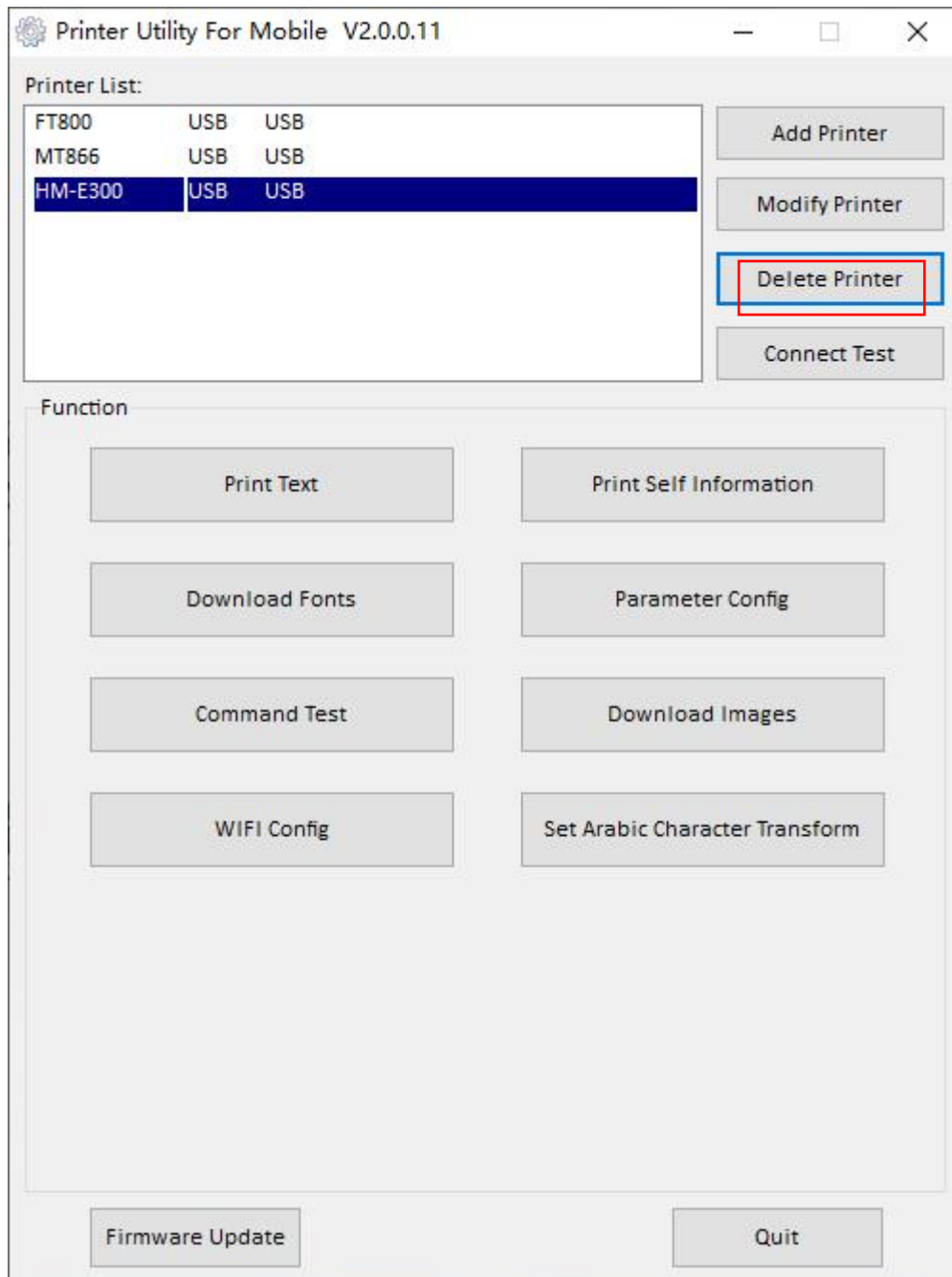

2. Click "OK", then the printer is deleted.

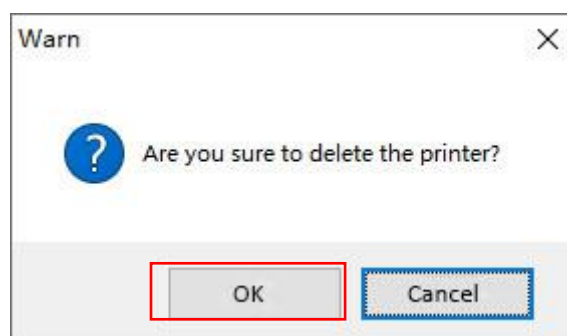

11.3.4 Connection Test

1. Click “Connection Test”. If the connection is successful, it will appear the following window. If the connection is unsuccessful, please connect the printer with computer.



Note:

- 1) Make sure printer is connected with computer and power on.
- 2) Make sure printer is loaded paper.
- 3) Before using the following function, carry out the “Connection Test” first.

11.4 Functions

The function of this printer utility is as follows. Click the button and printer will execute the appropriate action.

Note: The following display differs depending on the model you connected.

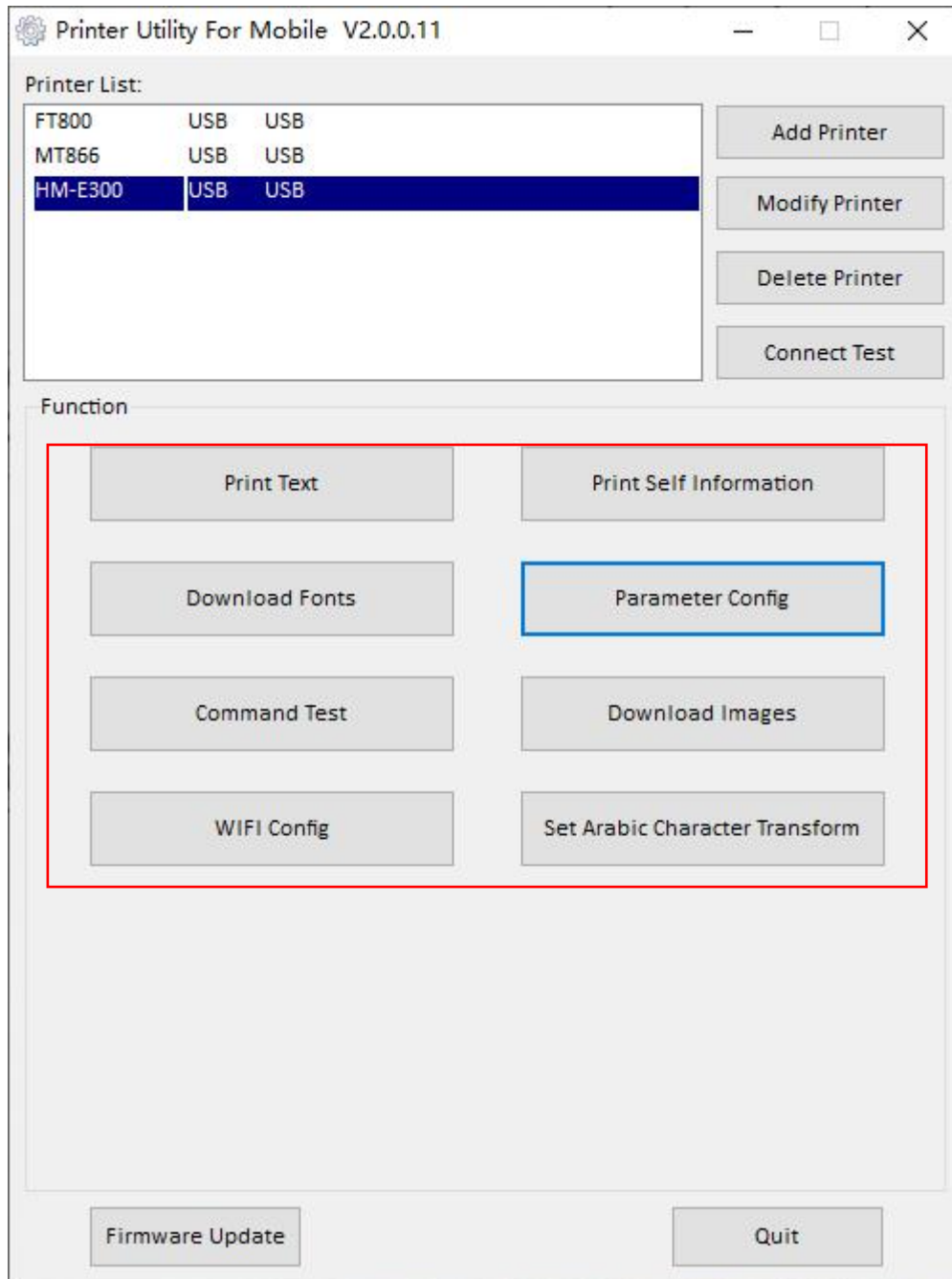

11.4.1 Print Text

Click “Print Text”, enter the text as needed and click “Print” to print it out.

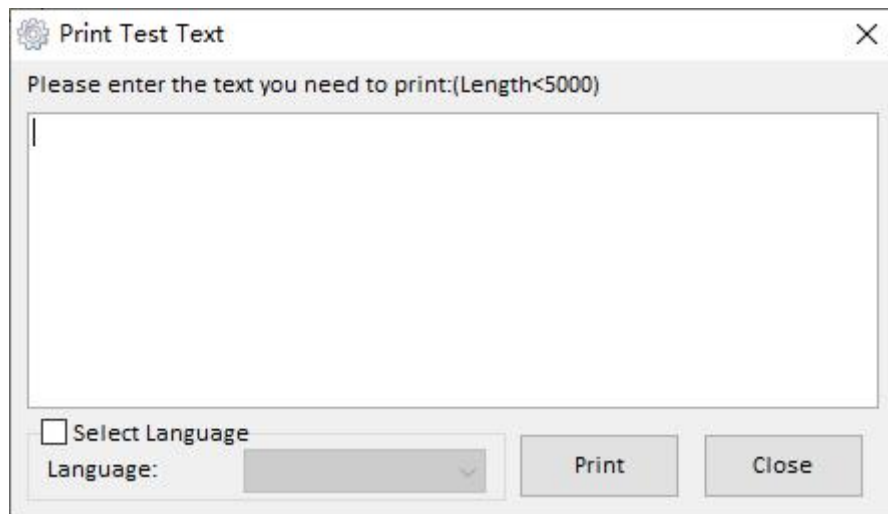

11.4.2 Print Self Information

Click “Print Self Information” and the printer will print out the setting information.

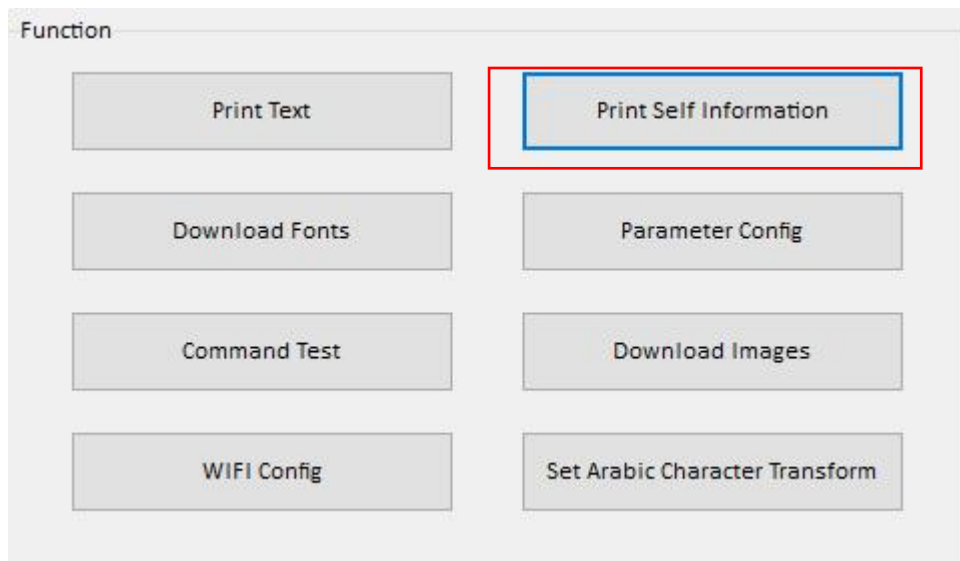

11.4.3 Download Fonts

Click “Download Fonts”, choose the font from existing files and click “Download”.



11.4.4 Parameter Configuration

Click “Parameter Config” , set up “Bluetooth”, “Print Density”, “Paper Type”, “Stand By Time”, “Language Mode” , “Codepage” as need. After finish setting, click “Set”to save it.

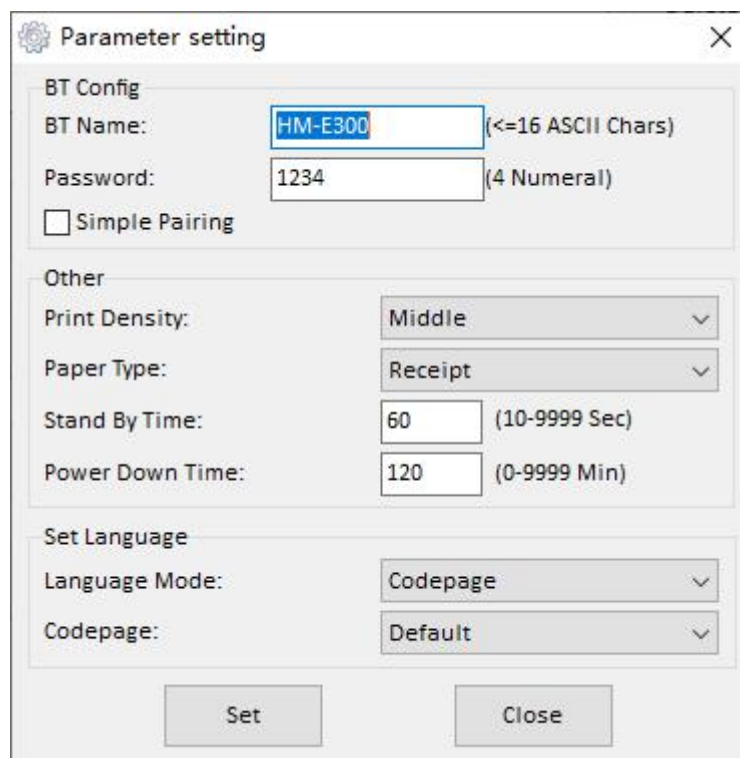

11.4.5 Command Test

Click “Command Test”, load file or input the data in the input box and click “Send” to print the test text.

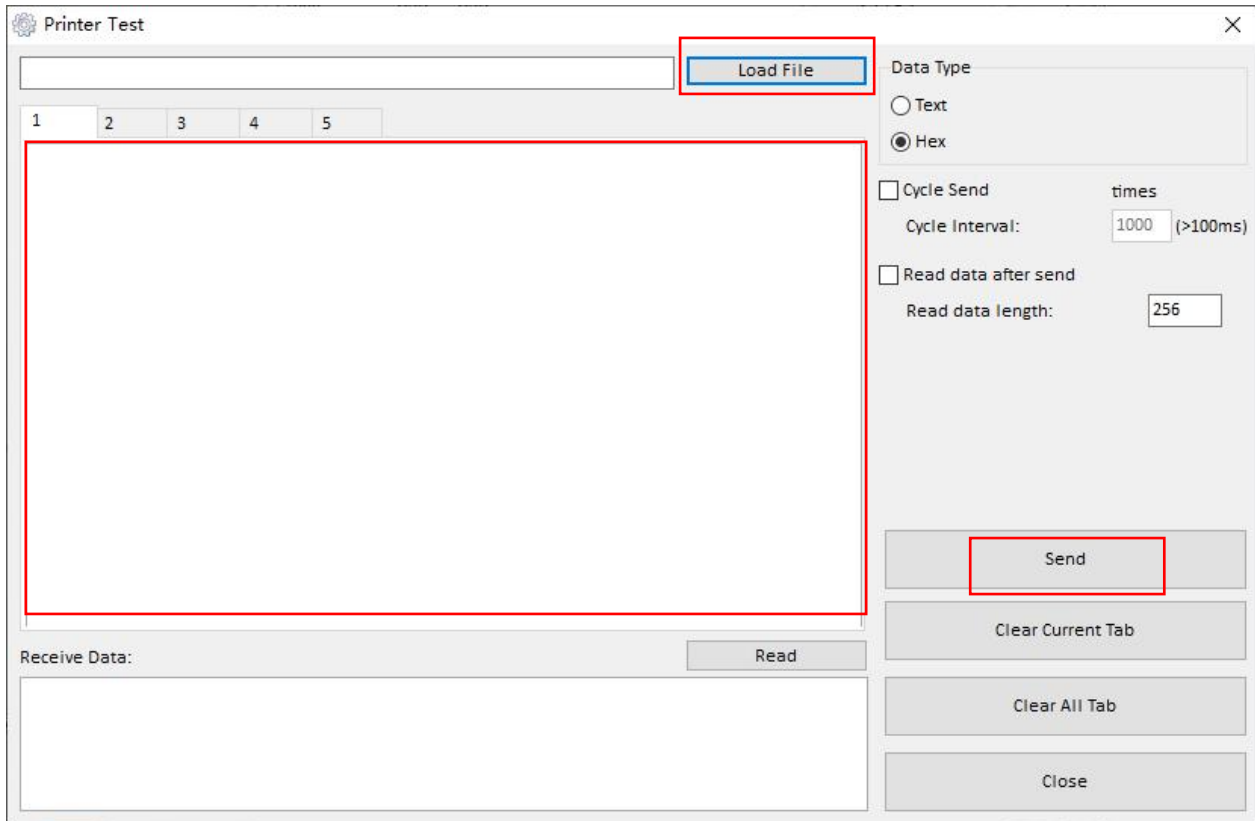

11.4.6 Download Images

Click “Download Images”, click “Add” to choose the picture you want to print, click “Download”, the printer will print the picture.

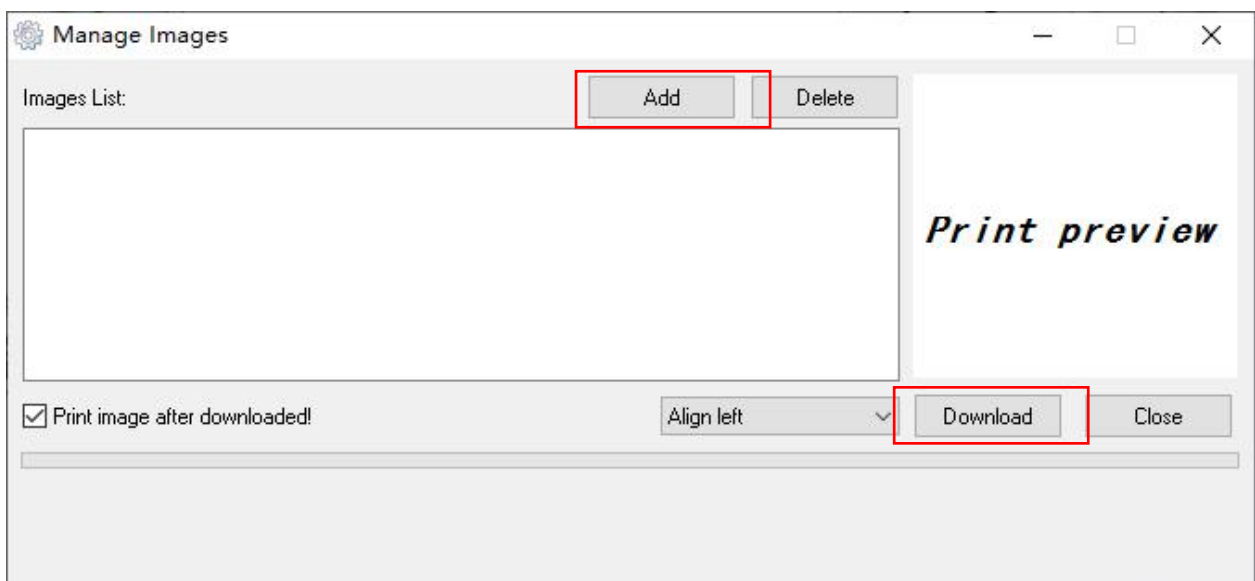

11.4.7 WIFI Configuration

Click “Set Arabic Character Transform”, select the item as below and then click “Set”.

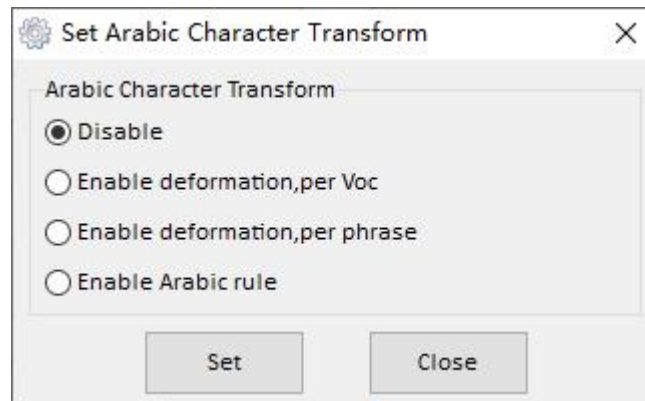

11.5 Firmware Update

Click “Firmware Update”, select the existing file and click “Download”. After update succeed, the printer will be restarted.

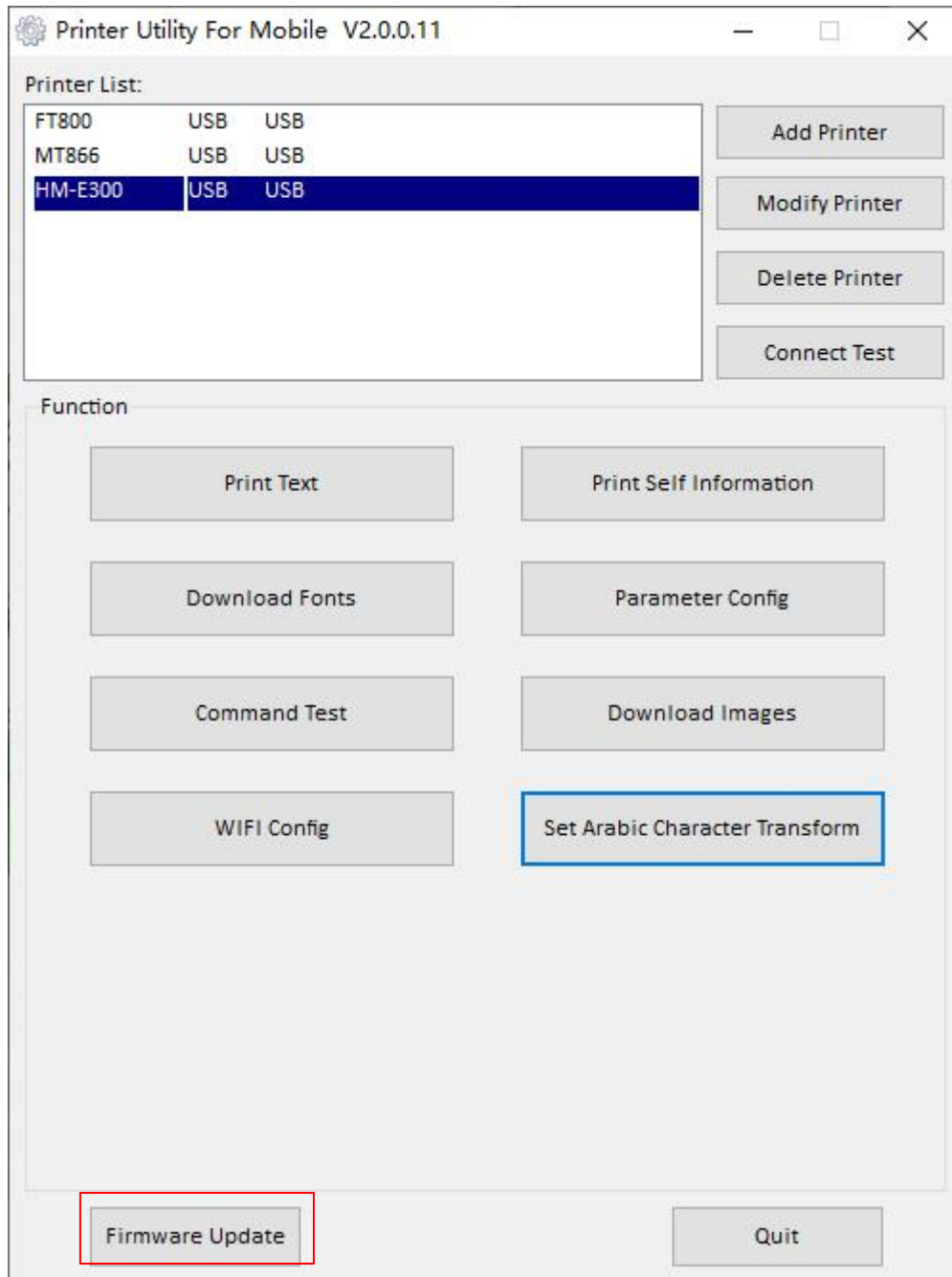

FCC WARNING

This device complies with part 15 of the FCC Rules. Operation is subject to the following two conditions: (1) this device may not cause harmful interference, and (2) this device must accept any interference received, including interference that may cause undesired operation.

Any changes or modifications not expressly approved by the party responsible for compliance could void the user's authority to operate the equipment.

NOTE: This equipment has been tested and found to comply with the limits for a Class B digital device, pursuant to Part 15 of the FCC Rules. These limits are designed to provide reasonable protection against harmful interference in a residential installation. This equipment generates, uses and can radiate radio frequency energy and, if not installed and used in accordance with the instructions, may cause harmful interference to radio communications. However, there is no guarantee that interference will not occur in a particular installation.

If this equipment does cause harmful interference to radio or television reception, which can be determined by turning the equipment off and on, the user is encouraged to try to correct the interference by one or more of the following measures:

- Reorient or relocate the receiving antenna.
- Increase the separation between the equipment and receiver.
- Connect the equipment into an outlet on a circuit different from that to which the receiver is connected.
- Consult the dealer or an experienced radio/TV technician for help.

To maintain compliance with FCC's RF Exposure guidelines, This equipment should be installed and operated with minimum distance between 20cm the radiator your body: Use only the supplied antenna.

UKCA WARNING

This product is a portable device. To comply with RF exposure requirements, a minimum separation distance of 0mm must be maintained between the user's body and the product, including the antenna. Third-party belt-clips, holsters, and similar accessories used by this device should not contain any metallic components. Body-worn accessories that do not meet these requirements may not comply with RF exposure requirements and should be avoided. Use only the supplied or an approved antenna.

This device in compliance with the essential requirements and other relevant provisions of UK Radio Equipment Regulations (SI 2017/1206); UK Electrical Equipment (Safety) Regulations (SI 2016/1101); and UK Electromagnetic Compatibility Regulations (SI 2016/1091).. All essential radio test suites have been carried out.

UK Declaration of Conformity

Hereby, Xiamen Hanin Electronic Technology Co.,Ltd. declares that the product type HM-E200 is in compliance with following Directives: Radio Equipment Regulations 2017, Electrical Equipment (Safety) Regulations 2016 and The Restriction of the Use of Certain Hazardous Substances in Electrical and Electronic Equipment Regulations 2012.

Wireless specification:

Function	frequency band	Max power	Limit
2.4G BR&EDR	2402-2480MHz	2.68dbm	20dBm
2.4G BLE	2402-2480MHz	5.45dbm	20dBm